

1989 EX500 PARTS DIAGRAM

Cylinder Head Cover

E1112-0097

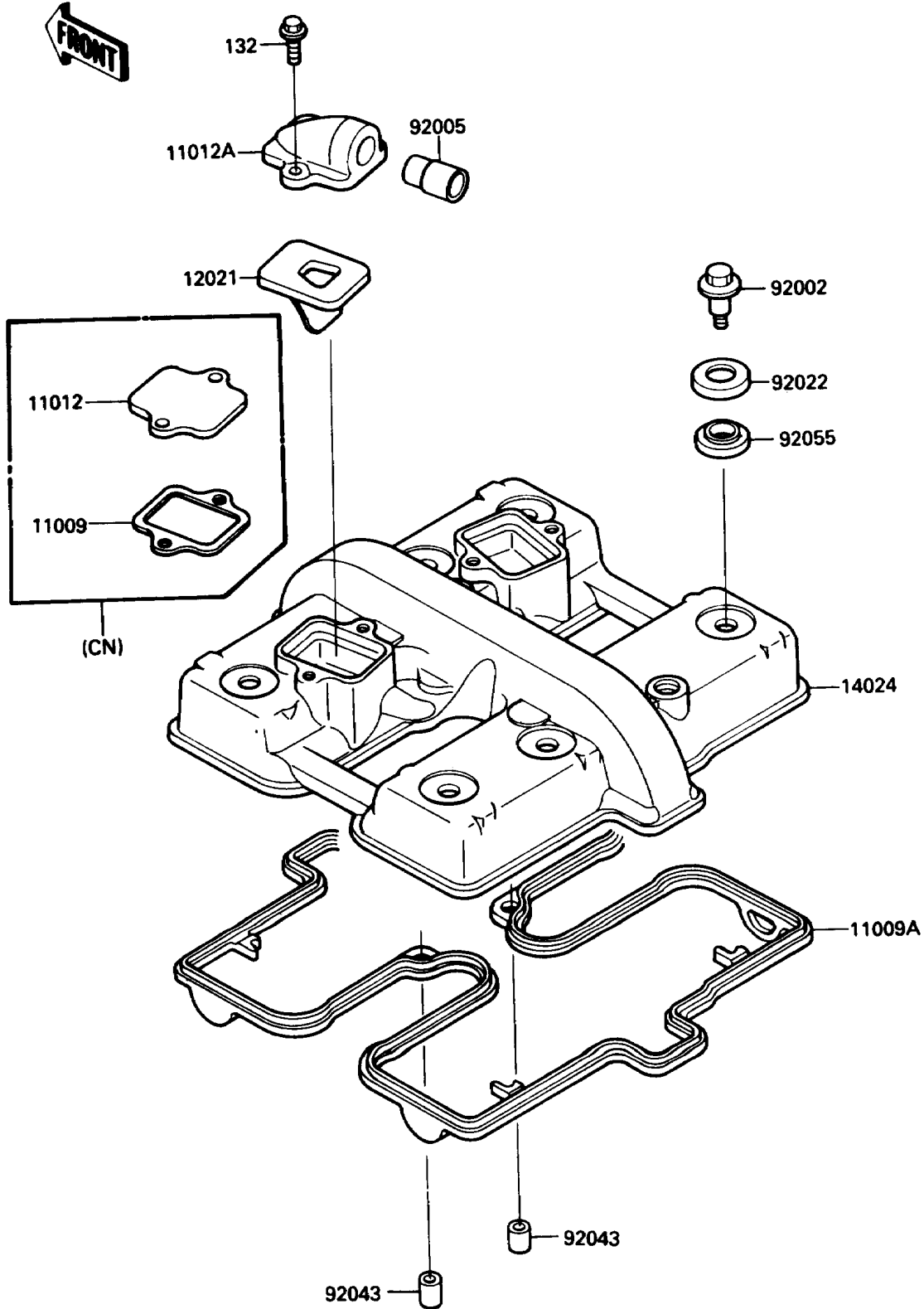

1989 EX500 PARTS LIST

Cylinder Head Cover

ITEM NAME	PART NUMBER	QUANTITY
GASKET, REED VALVE (Ref # 11009)	11009-1246	2
GASKET, CYLINDER HEAD COVER (Ref # 11009A)	11009-1483	1
CAP, CYLINDER HEAD COVER (Ref # 11012)	11012-1212	2
CAP, REED VALVE (Ref # 11012A)	11012-1310	2
VALVE-ASSY-REED (Ref # 12021)	12021-1026	2
COVER, CYLINDER HEAD (Ref # 14024)	14024-1397	1
BOLT, HEAD COVER (Ref # 92002)	92002-1504	6
FITTING, REED VALVE (Ref # 92005)	92005-1006	2
WASHER, HEAD COVER BOLT (Ref # 92022)	92022-1487	6
PIN, DOWEL, 8X10 (Ref # 92043)	92043-1302	2
RING-O, HEAD COVER BOLT (Ref # 92055)	92055-1225	6
BOLT-FLANGED-SMALL (Ref # 132)	132J0616	4