

2001 Ninja® 250R PARTS DIAGRAM

Brake Pedal/Torque Link

F2260

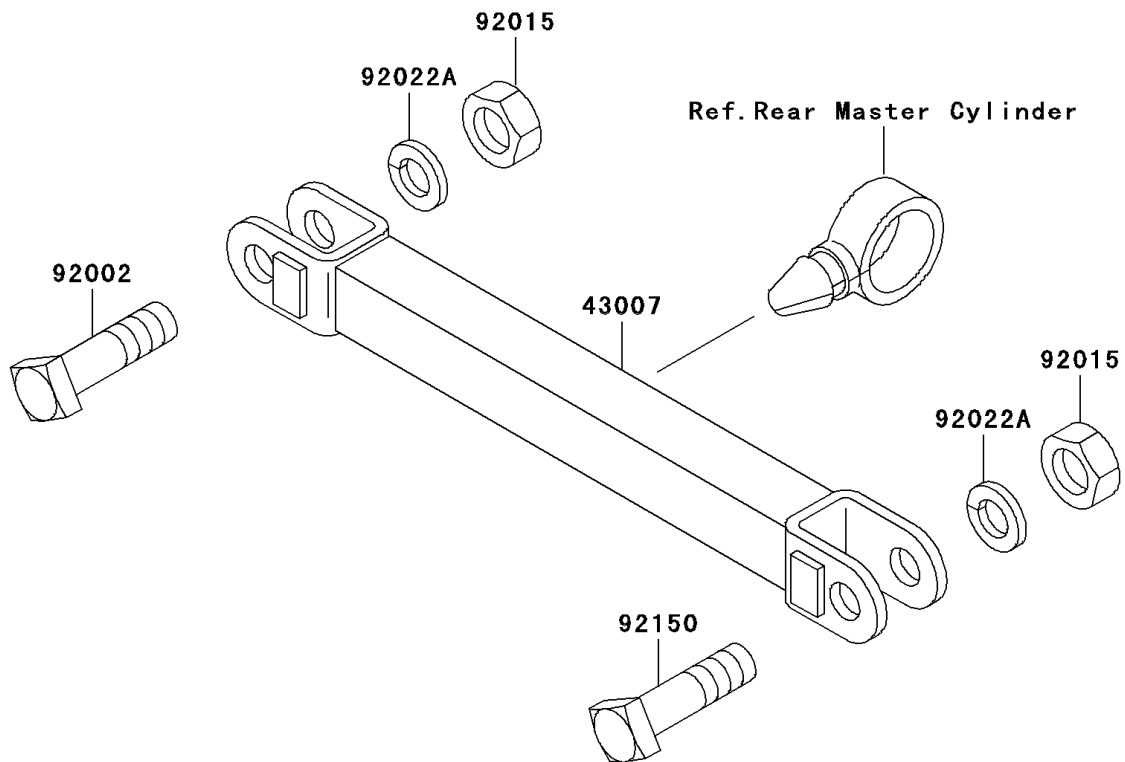
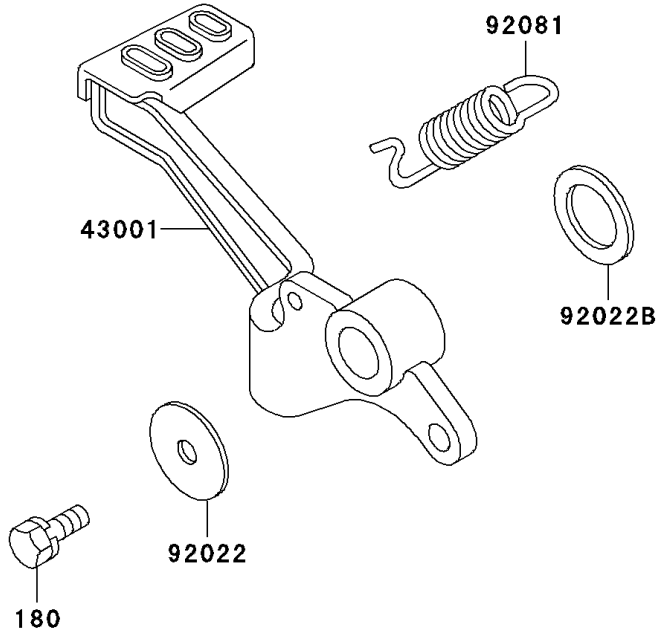

2001 Ninja® 250R PARTS LIST

Brake Pedal/Torque Link

ITEM NAME	PART NUMBER	QUANTITY
BOLT-UPSET-WS (Ref # 180)	180D0616	1
LEVER-BRAKE,PEDAL (Ref # 43001)	43001-1226	1
ROD-TORQUE (Ref # 43007)	43007-1134	1
BOLT,10X32 (Ref # 92002)	92002-1708	1
NUT,LOCK,10MM (Ref # 92015)	92015-1962	2
WASHER,7X28X1.6 (Ref # 92022)	92022-1282	1
WASHER,SPRING,10MM (Ref # 92022A)	92022-1540	2
WASHER,15.3X24X1 (Ref # 92022B)	92022-326	1
SPRING,BRAKE PEDAL (Ref # 92081)	92081-1833	1
BOLT,10X37 (Ref # 92150)	92150-1901	1