

2007 ER-6n (Australian) PARTS DIAGRAM

Oil Pump

E1710

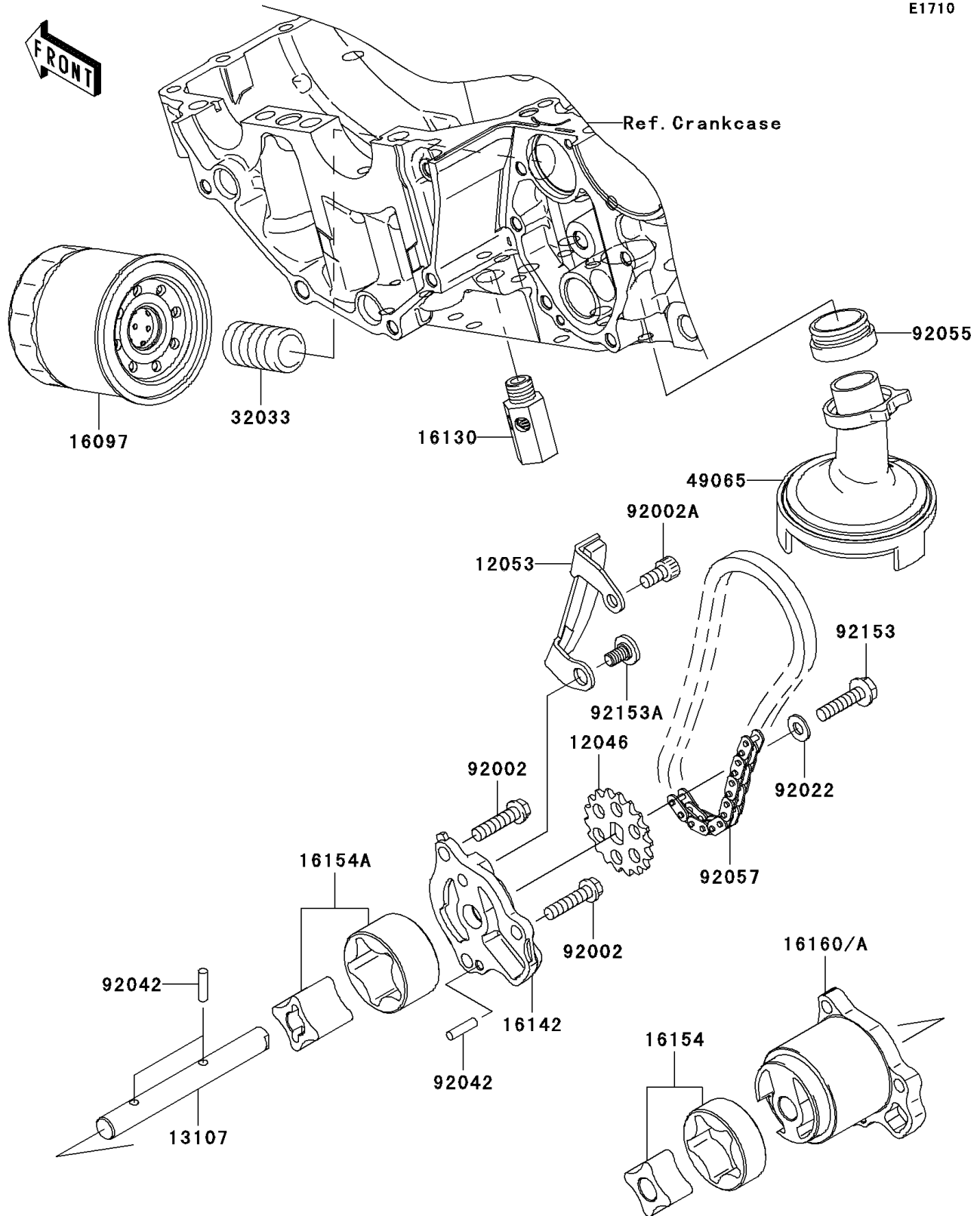

2007 ER-6n (Australian) PARTS LIST

Oil Pump

ITEM NAME	PART NUMBER	QUANTITY
SPROCKET,18T,BF04M (Ref # 12046)	12046-0040	1
GUIDE-CHAIN (Ref # 12053)	12053-0071	1
SHAFT,OIL PUMP (Ref # 13107)	13107-0156	1
FILTER-ASSY-OIL (Ref # 16097)	16097-0004	1
VALVE-ASSY-RELIEF (Ref # 16130)	16130-1058	1
COVER-PUMP (Ref # 16142)	16142-0024	1
ROTOR-PUMP,L=14 (Ref # 16154)	16154-0037	1
ROTOR-PUMP,40.56X22 (Ref # 16154A)	16154-1115	1
BODY (Ref # 16160A)	16160-0110	1
PIPE,OIL FILTER (Ref # 32033)	32033-1535	1
FILTER-OIL (Ref # 49065)	49065-0011	1
BOLT,6X25 (Ref # 92002)	92002-1344	3
BOLT,SOCKET,6X12 (Ref # 92002A)	92002-1796	1
WASHER,6X12.8X1.2 (Ref # 92022)	92022-1827	1
PIN,DOWEL,4X15.8 (Ref # 92042)	92042-014	3
RING-O,OIL FILTER (Ref # 92055)	92055-1354	1
CHAIN,DID 215FD-DHA,56LE (Ref # 92057)	92057-0098	1
BOLT,FLANGED,6X25 (Ref # 92153)	92153-0952	1
BOLT,SOCKET,6X11 (Ref # 92153A)	92153-0969	1