

2003 Vulcan 500 LTD PARTS DIAGRAM

Swingarm

F2141

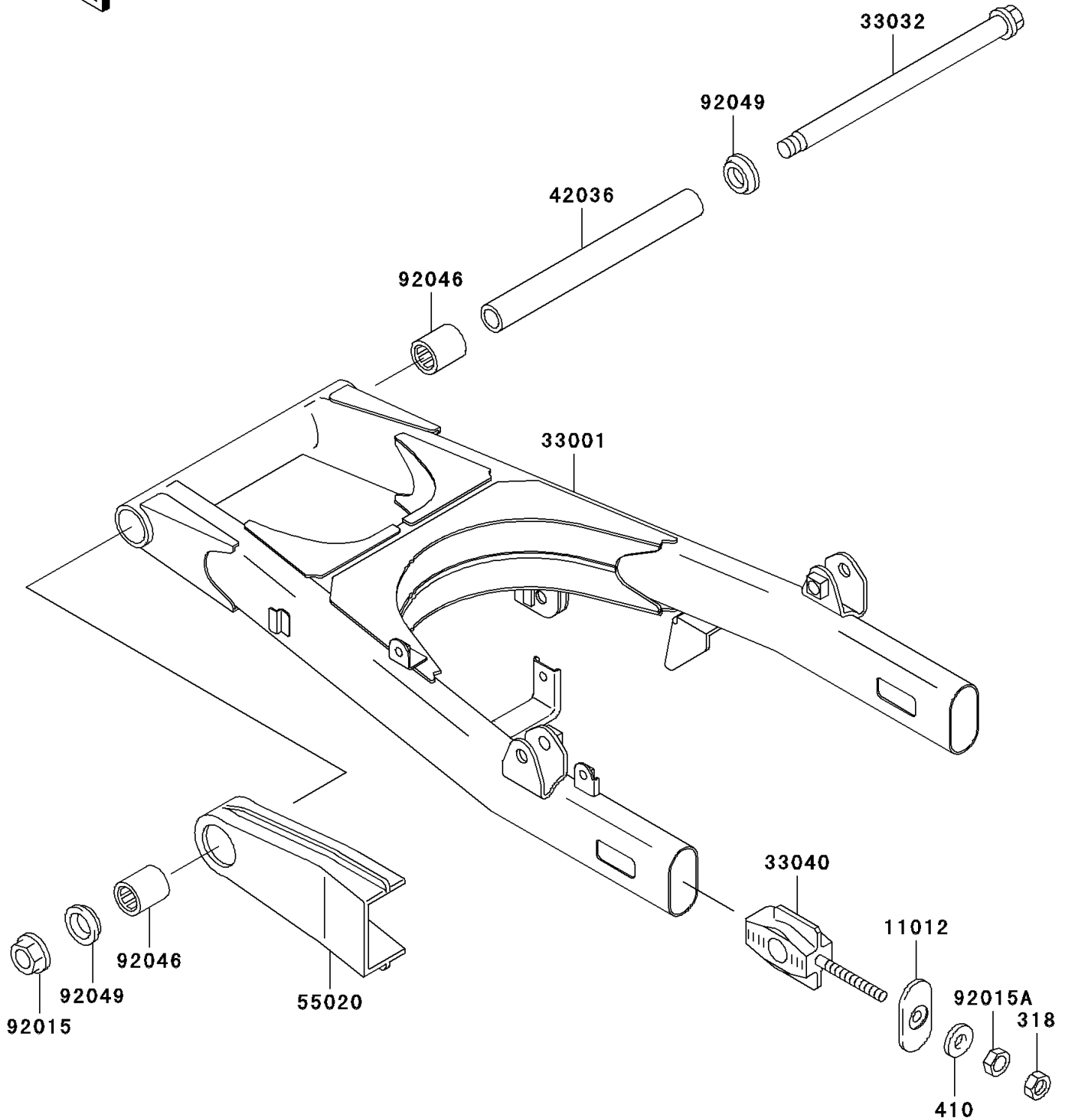

2003 Vulcan 500 LTD PARTS LIST

Swingarm

ITEM NAME	PART NUMBER	QUANTITY
NUT-HEX-SMALL (Ref # 318)	318C0800	2
WASHER-PLAIN-SMALL,8MM,BLACK (Ref # 410)	410F0800	2
CAP,CHAIN ADJUSTER (Ref # 11012)	11012-1819	2
ARM-COMP-SWING (Ref # 33001)	33001-1499	1
SHAFT-SWING ARM (Ref # 33032)	33032-1180	1
ADJUSTER-CHAIN,INNER (Ref # 33040)	33040-1140	2
SLEEVE,SWING ARM,L=228.5 (Ref # 42036)	42036-1329	1
GUARD,CHAIN (Ref # 55020)	55020-1559	1
NUT,14MM (Ref # 92015)	92015-1407	1
NUT,8MM (Ref # 92015A)	92015-1959	2
BEARING-NEEDLE,TA2230Z (Ref # 92046)	92046-1174	2
SEAL-OIL,MHA22X29X5.7F (Ref # 92049)	92049-1289	2