

2003 Vulcan 500 LTD PARTS DIAGRAM

Engine Mount

F2122

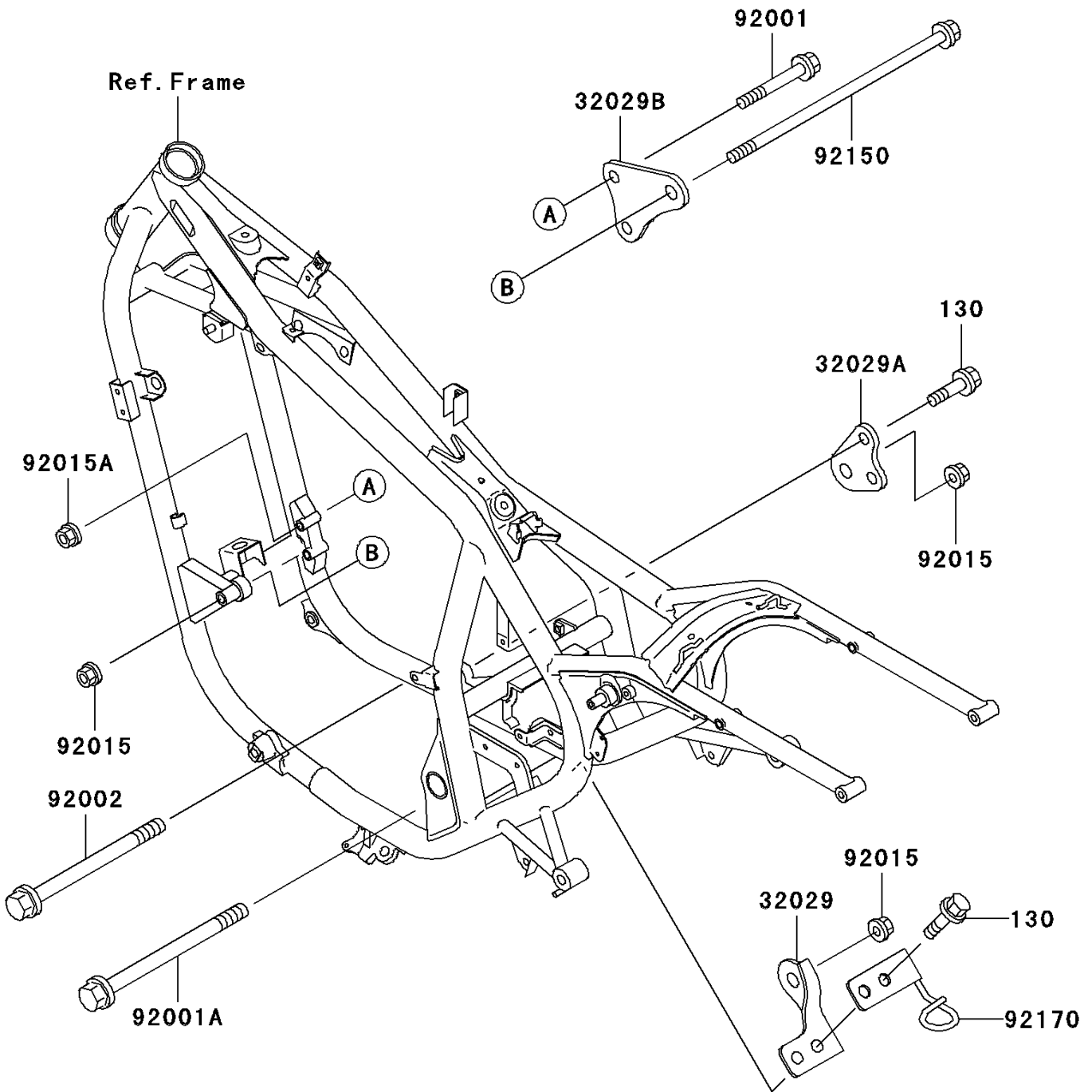

2003 Vulcan 500 LTD PARTS LIST

Engine Mount

ITEM NAME	PART NUMBER	QUANTITY
BOLT-FLANGED,8X16,BLACK (Ref # 130)	130J0816	4
BRACKET-ENGINE,RR,LWR,RH (Ref # 32029)	32029-1379	1
BRACKET-ENGINE,RR,RH,UPP (Ref # 32029A)	32029-1974	1
BRACKET-ENGINE,FR,RH (Ref # 32029B)	32029-1975	1
BOLT,FLANGED,8X45 (Ref # 92001)	92001-1613	2
BOLT,FLANGED,10X180 (Ref # 92001A)	92001-1621	1
BOLT,FLANGED,10X170 (Ref # 92002)	92002-1470	1
NUT,FLANGED,10MM (Ref # 92015)	92015-1180	3
NUT,FLANGED,8MM,BLACK (Ref # 92015A)	92015-1251	2
BOLT,FLANGED,10X240 (Ref # 92150)	92150-1742	1
CLAMP,HOSE (Ref # 92170)	92170-1711	1