

2001 Vulcan 500 LTD PARTS DIAGRAM

Clutch

E1350

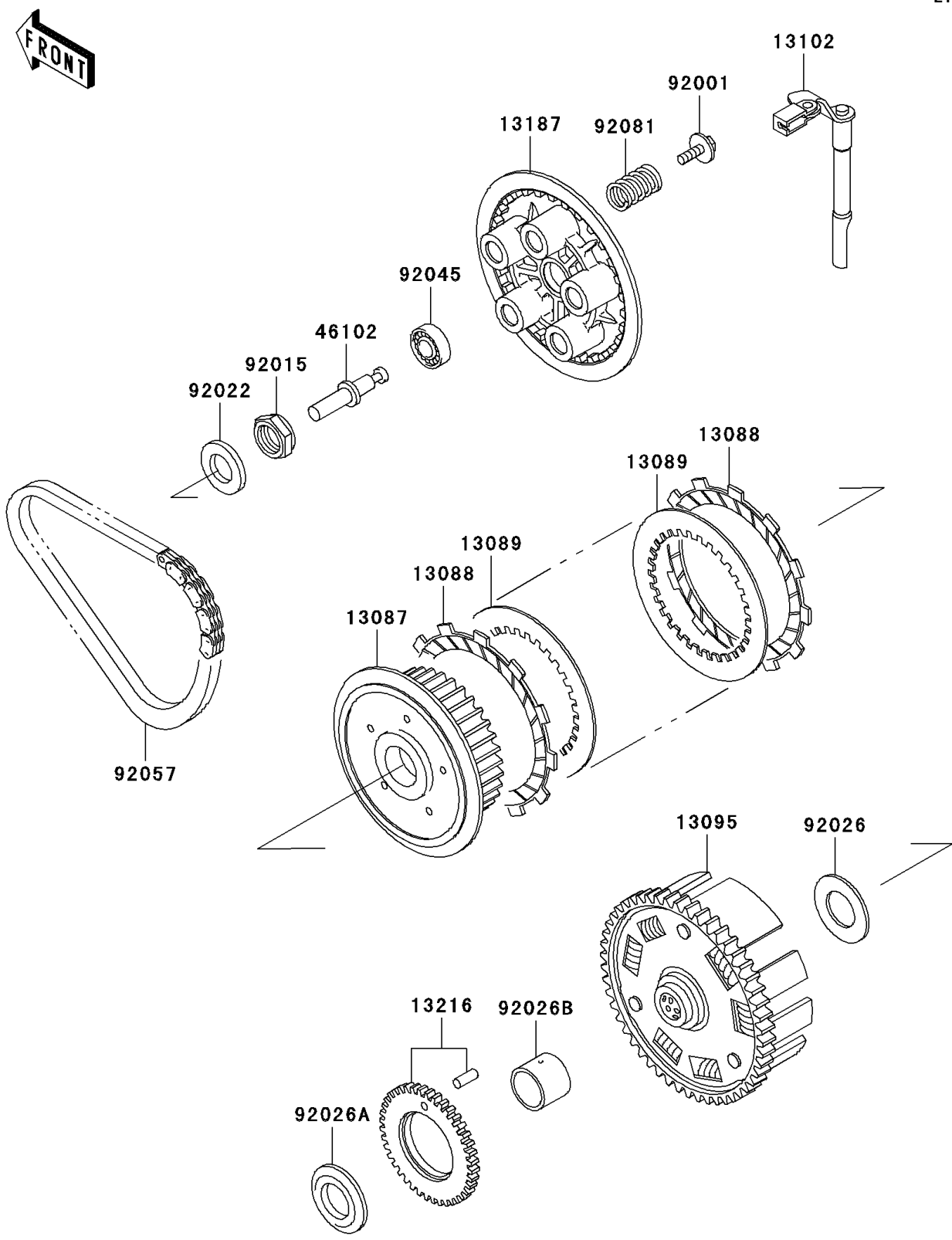

2001 Vulcan 500 LTD PARTS LIST

Clutch

ITEM NAME	PART NUMBER	QUANTITY
HUB-CLUTCH (Ref # 13087)	13087-1162	1
PLATE-FRICTION (Ref # 13088)	13088-1013	7
PLATE-CLUTCH,T=2.0 (Ref # 13089)	13089-026	6
HOUSING-COMP-CLUTCH (Ref # 13095)	13095-1158	1
RELEASE-COMP-CLUTCH (Ref # 13102)	13102-1108	1
PLATE-CLUTCH OPERATING (Ref # 13187)	13187-1087	1
GEAR-COMP,40T (Ref # 13216)	13216-1066	1
ROD,CLUTCH (Ref # 46102)	46102-1134	1
BOLT,FLANGED,6X18 (Ref # 92001)	92001-1066	5
NUT,20MM (Ref # 92015)	92015-1555	1
WASHER,20.3X36X2.3 (Ref # 92022)	92022-1116	1
SPACER,25.5X47X2.5 (Ref # 92026)	92026-022	1
SPACER (Ref # 92026A)	92026-1242	1
SPACER,25X30X23.5 (Ref # 92026B)	92026-1243	1
BEARING-BALL,6001C3ML01 (Ref # 92045)	92045-1235	1
CHAIN,PRIMARY (Ref # 92057)	92057-1229	1
SPRING,CLUTCH (Ref # 92081)	92081-1864	5