

2005 Vulcan 500 LTD PARTS DIAGRAM

Frame Fittings

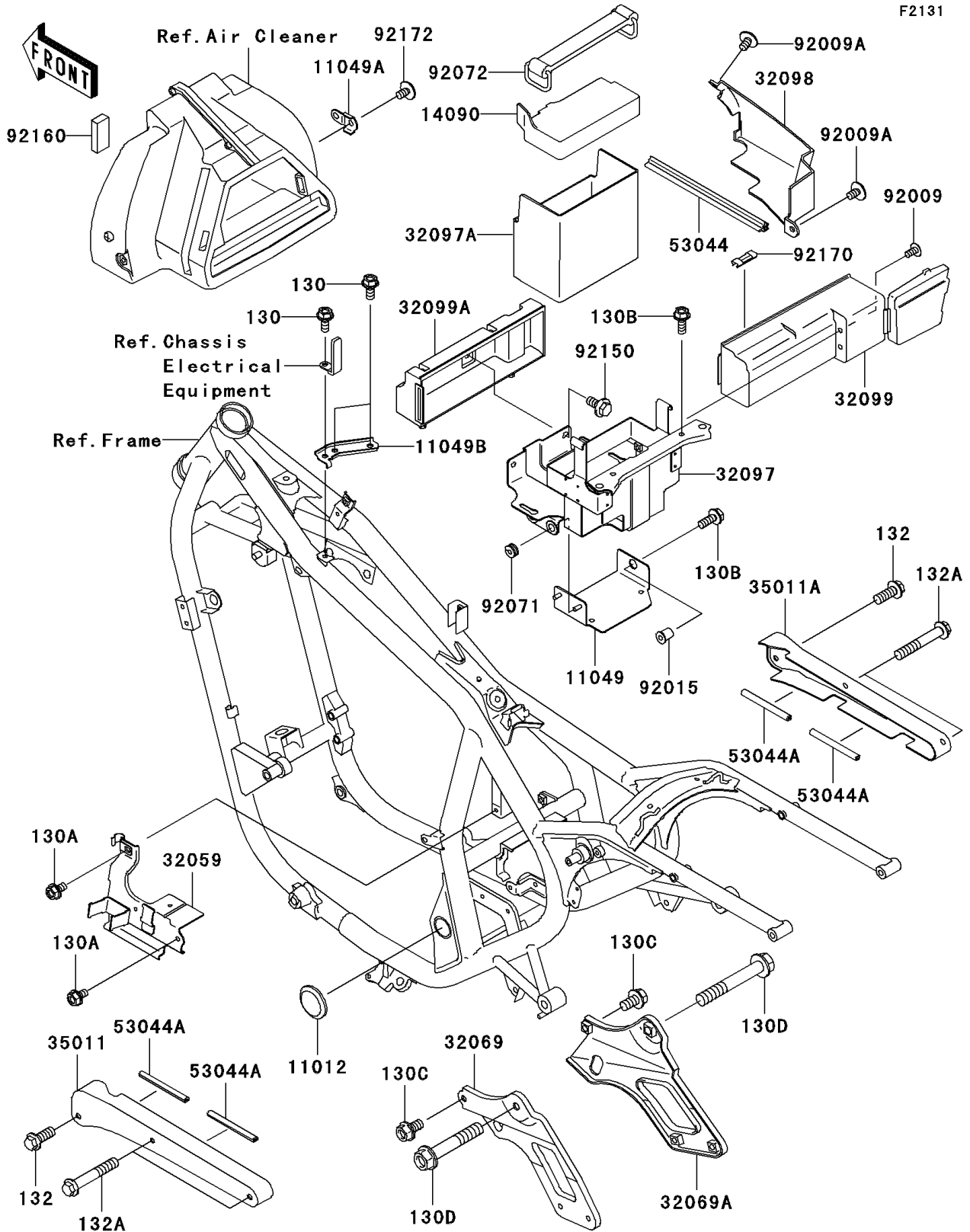

2005 Vulcan 500 LTD PARTS LIST

Frame Fittings

ITEM NAME	PART NUMBER	QUANTITY
BOLT-FLANGED,6X14 (Ref # 130)	130G0614	3
BOLT-FLANGED (Ref # 130A)	130J0610	2
BOLT-FLANGED,6X16,BLACK (Ref # 130B)	130J0616	3
BOLT-FLANGED,8X14 (Ref # 130C)	130J0814	2
BOLT-FLANGED,10X55 (Ref # 130D)	130J1055	2
BOLT-FLANGED-SMALL (Ref # 132)	132E0820	2
BOLT-FLANGED-SMALL (Ref # 132A)	132E0850	4
CAP,PIVOT (Ref # 11012)	11012-1821	2
BRACKET,IGNITER (Ref # 11049)	11049-1576	1
BRACKET,AIR CLEANER (Ref # 11049A)	11049-1577	1
BRACKET,THERMOSTAT (Ref # 11049B)	11049-1795	1
COVER,BATTERY (Ref # 14090)	14090-1688	1
BRACKET-SWITCH (Ref # 32059)	32059-1132	1
BRACKET-MUFFLER,LH (Ref # 32069)	32069-1453	1
BRACKET-MUFFLER,RH (Ref # 32069A)	32069-1454	1
CASE-BATTERY (Ref # 32097)	32097-1160	1
CASE-BATTERY (Ref # 32097A)	32097-1163	1
CASE-TOOL (Ref # 32098)	32098-1110	1
CASE (Ref # 32099)	32099-1170	1
CASE (Ref # 32099A)	32099-1177	1
STAY,LH (Ref # 35011)	35011-1757	1
STAY,RH (Ref # 35011A)	35011-1758	1
TRIM,L=200 (Ref # 53044)	53044-1299	1
TRIM,L=100 (Ref # 53044A)	53044-3728	4
SCREW,5X10 (Ref # 92009)	92009-1651	2
SCREW,6X10 (Ref # 92009A)	92009-1661	2
NUT (Ref # 92015)	92015-1700	1
GROMMET (Ref # 92071)	92071-3733	2
BAND,L=142.1 (Ref # 92072)	92072-006	1

2005 Vulcan 500 LTD PARTS LIST

Frame Fittings

ITEM NAME	PART NUMBER	QUANTITY
BOLT,6X16 (Ref # 92150)	92150-1198	2
DAMPER (Ref # 92160)	92160-1439	1
CLAMP (Ref # 92170)	92170-1646	1
SCREW,6X10 (Ref # 92172)	92172-0005	1