

1998 Vulcan 500 LTD PARTS DIAGRAM

Chassis Electrical Equipment

F2760

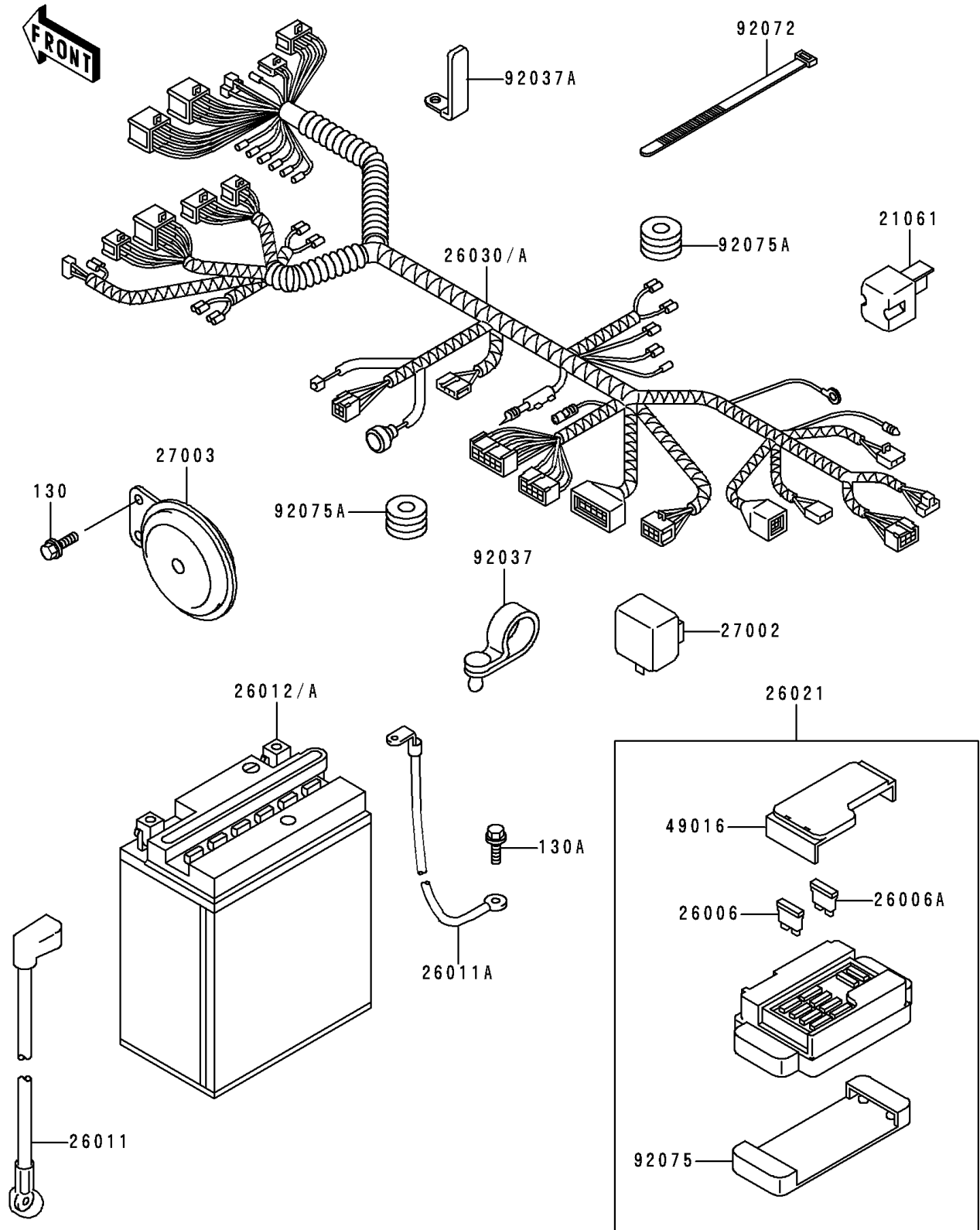

1998 Vulcan 500 LTD PARTS LIST

Chassis Electrical Equipment

ITEM NAME	PART NUMBER	QUANTITY
BOLT-FLANGED (Ref # 130)	130J0612	2
BOLT-FLANGED,6X10 (Ref # 130A)	130V0610	1
RECTIFIER (Ref # 21061)	21061-1003	2
FUSE,30A-G (Ref # 26006)	26006-1067	1
FUSE,10A-R (Ref # 26006A)	26006-1068	8
WIRE-LEAD,BATTERY(+) (Ref # 26011)	26011-1642	1
WIRE-LEAD,BATTERY(-) (Ref # 26011A)	26011-1643	1
BATTERY,YB12AL-A2,12V 12AH (Ref # 26012A)	26012-1342	1
JUNCTION BOX (Ref # 26021)	26021-1089	1
HARNESS,MAIN (Ref # 26030)	26030-1445	1
RELAY-ASSY,TURN SIGNAL (Ref # 27002)	27002-1101	1
HORN (Ref # 27003)	27003-1392	1
COVER-SEAL,FUSE (Ref # 49016)	49016-1177	1
CLAMP,SPEED,L=58 (Ref # 92037)	92037-1163	2
CLAMP (Ref # 92037A)	92037-1679	1
BAND,L=185 (Ref # 92072)	92072-1195	12
DAMPER,JUNCTION BOX (Ref # 92075)	92075-1688	1
DAMPER (Ref # 92075A)	92075-294	2