

1999 Vulcan 500 LTD PARTS DIAGRAM

Headlight(s)

F2710

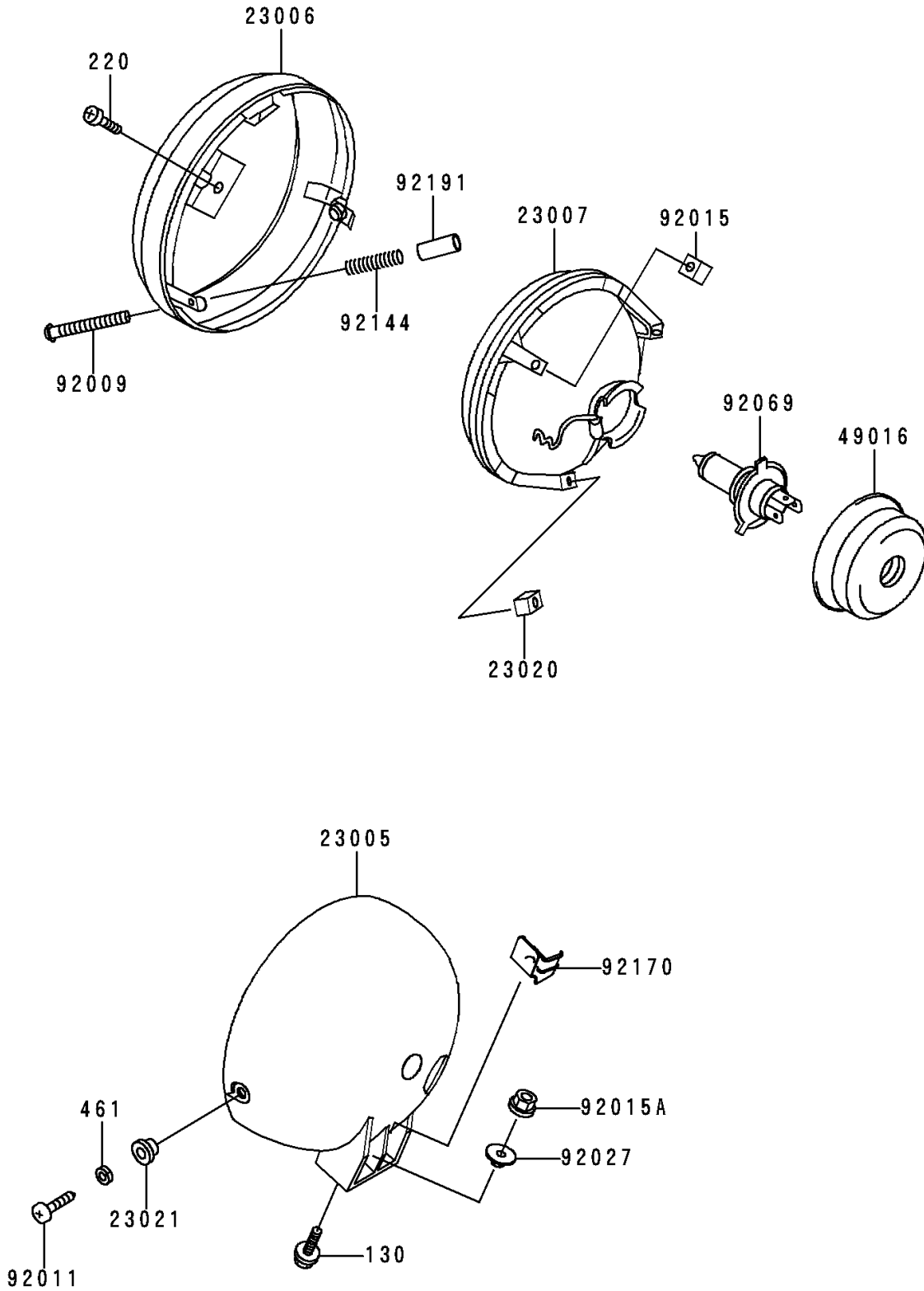

1999 Vulcan 500 LTD PARTS LIST

Headlight(s)

ITEM NAME	PART NUMBER	QUANTITY
BOLT-FLANGED (Ref # 130)	130V0620	2
SCREW-PAN-CROS,5X12 (Ref # 220)	220D0512	1
WASHER-SPRING,5MM (Ref # 461)	461F0500	2
BODY-COMP-HEAD LAMP (Ref # 23005)	23005-1149	1
RIM-LAMP (Ref # 23006)	23006-1070	1
LENS-COMP,HEAD LAMP (Ref # 23007)	23007-1169	1
NUT,4MM,FOCUS ADJUST (Ref # 23020)	23020-018	2
WASHER (Ref # 23021)	23021-010	2
COVER-SEAL,HEAD LAMP SOCKET (Ref # 49016)	49016-1129	1
SCREW,FOCUS ADJUST,4X65 (Ref # 92009)	92009-1472	2
SCREW,5MM (Ref # 92011)	92011-024	2
NUT,5MM (Ref # 92015)	92015-1157	1
NUT,FLANGED,6MM (Ref # 92015A)	92015-1367	1
COLLAR,L=6.5 (Ref # 92027)	92027-252	2
BULB,12V 60/55W,H4 (Ref # 92069)	92069-1002	1
SPRING,FOCUS ADJUST (Ref # 92144)	92144-1149	2
CLAMP,HARNESS (Ref # 92170)	92170-1624	1
TUBE,3.5X4.5X19 (Ref # 92191)	92191-1217	2