

1991 Vulcan 500 PARTS DIAGRAM

Chassis Electrical Equipment

F2760

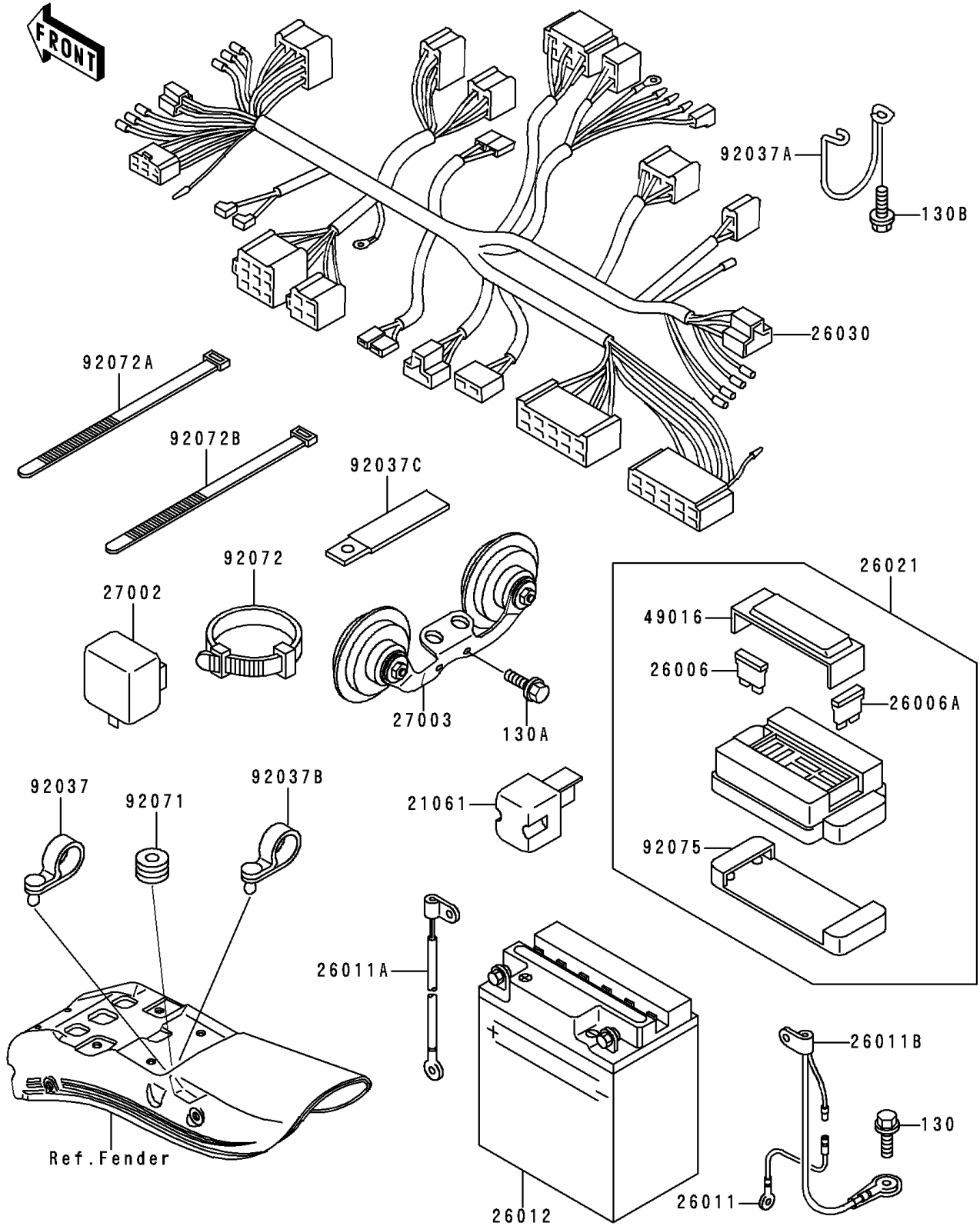

1991 Vulcan 500 PARTS LIST

Chassis Electrical Equipment

ITEM NAME	PART NUMBER	QUANTITY
BOLT-FLANGED,6X10 (Ref # 130)	130B0610	1
BOLT-FLANGED,6X10,BLACK (Ref # 130A)	130C0610	2
BOLT-FLANGED,6X14 (Ref # 130B)	130C0614	2
RECTIFIER (Ref # 21061)	21061-1003	2
FUSE,30A-G (Ref # 26006)	26006-1067	1
FUSE,10A-R (Ref # 26006A)	26006-1068	5
WIRE-LEAD,ACCESSORY GROUND (Ref # 26011)	26011-1100	1
WIRE-LEAD,BATTERY(+) (Ref # 26011A)	26011-1466	1
WIRE-LEAD,BATTERY(-) (Ref # 26011B)	26011-1467	1
BATTERY,FB12A-A,12V 12AH (Ref # 26012)	26012-1246	1
JUNCTION BOX (Ref # 26021)	26021-1077	1
HARNESS,MAIN (Ref # 26030)	26030-1012	1
RELAY-ASSY,TURN SIGNAL (Ref # 27002)	27002-1053	1
HORN (Ref # 27003)	27003-1323	1
COVER-SEAL,FUSE (Ref # 49016)	49016-1125	1
CLAMP,HOSE (Ref # 92037)	92037-1163	1
CLAMP,HARNESS (Ref # 92037A)	92037-1663	1
CLAMP (Ref # 92037B)	92037-1903	2
CLAMP (Ref # 92037C)	92037-1993	1
GROMMET (Ref # 92071)	92071-056	1
BAND,L=149 (Ref # 92072)	92072-031	4
BAND,L=185 (Ref # 92072A)	92072-1195	8
BAND,L=365 (Ref # 92072B)	92072-1197	2
DAMPER,JUNCTION BOX (Ref # 92075)	92075-1688	1