

1991 Vulcan 500 PARTS DIAGRAM

Cables

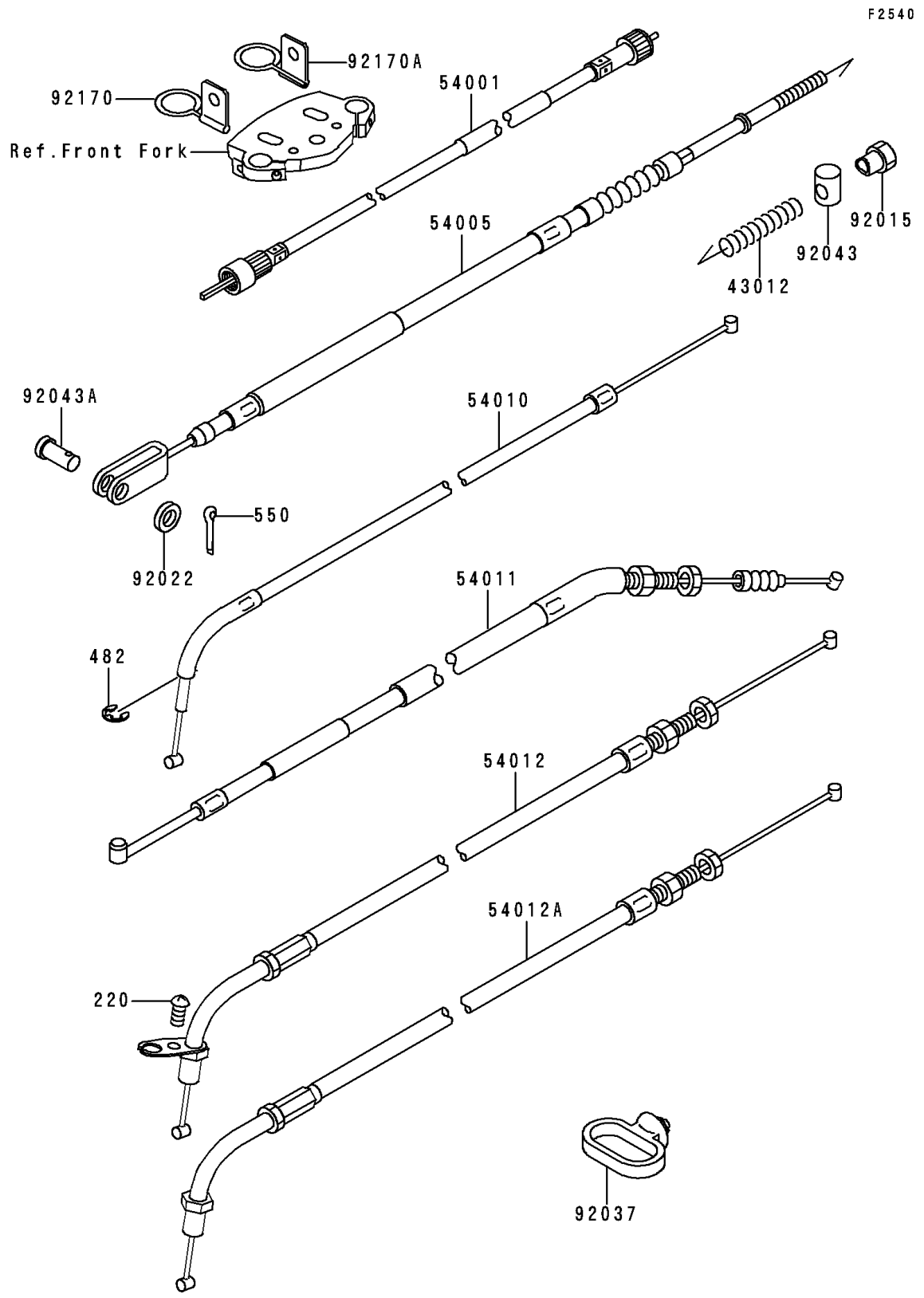

1991 Vulcan 500 PARTS LIST

Cables

| ITEM NAME | PART NUMBER | QUANTITY |
|---------------------------------------|-------------|----------|
| SCREW-PAN-CROS (Ref # 220) | 220C0514 | 1 |
| CIRCLIP-TYPE-E,5MM (Ref # 482) | 482L5000 | 1 |
| PIN-COTTER,2.0X15 (Ref # 550) | 550D2015 | 1 |
| SPRING,BRAKE ROD (Ref # 43012) | 43012-001 | 1 |
| CABLE-SPEEDOMETER (Ref # 54001) | 54001-1113 | 1 |
| CABLE-BRAKE (Ref # 54005) | 54005-1165 | 1 |
| CABLE,SEAT LOCK (Ref # 54010) | 54010-1080 | 1 |
| CABLE-CLUTCH (Ref # 54011) | 54011-1298 | 1 |
| CABLE-THROTTLE,CLOSING (Ref # 54012) | 54012-1265 | 1 |
| CABLE-THROTTLE,OPENING (Ref # 54012A) | 54012-1390 | 1 |
| NUT,BRAKE ROD (Ref # 92015) | 92015-042 | 1 |
| WASHER,8.5X16X1.2 (Ref # 92022) | 92022-1582 | 1 |
| CLAMP,CABLE (Ref # 92037) | 92037-1459 | 1 |
| PIN,BRAKE ROD (Ref # 92043) | 92043-065 | 1 |
| PIN,8X16 (Ref # 92043A) | 92043-1013 | 1 |
| CLAMP,CABLE,LH (Ref # 92170) | 92170-1162 | 1 |
| CLAMP,CABLE,RH (Ref # 92170A) | 92170-1163 | 1 |