

1990 Vulcan 500 PARTS DIAGRAM

Suspension/Shock Absorber

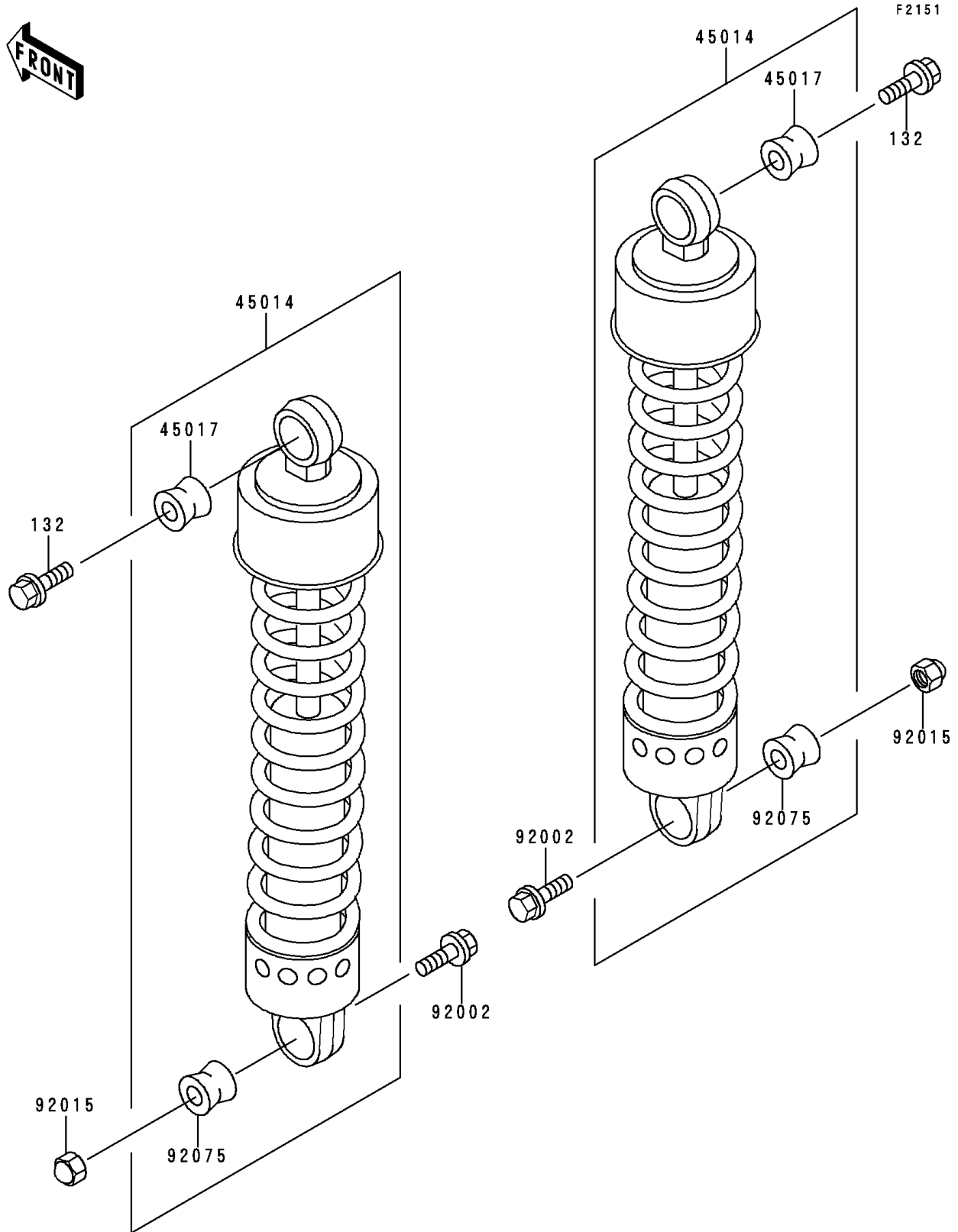

1990 Vulcan 500 PARTS LIST

Suspension/Shock Absorber

ITEM NAME	PART NUMBER	QUANTITY
BOLT-FLANGED-SMALL (Ref # 132)	132E0814	2
SHOCKABSORBER (Ref # 45014)	45014-1468	2
DAMPER,SHOCKABSORBER (Ref # 45017)	45017-015	2
BOLT,FLANGED,10X37 (Ref # 92002)	92002-1578	2
NUT,10MM (Ref # 92015)	92015-1649	2
DAMPER,SHOCKABSORBER,LWR (Ref # 92075)	92075-1499	2