

1990 Vulcan 500 PARTS DIAGRAM

Swingarm

F2141

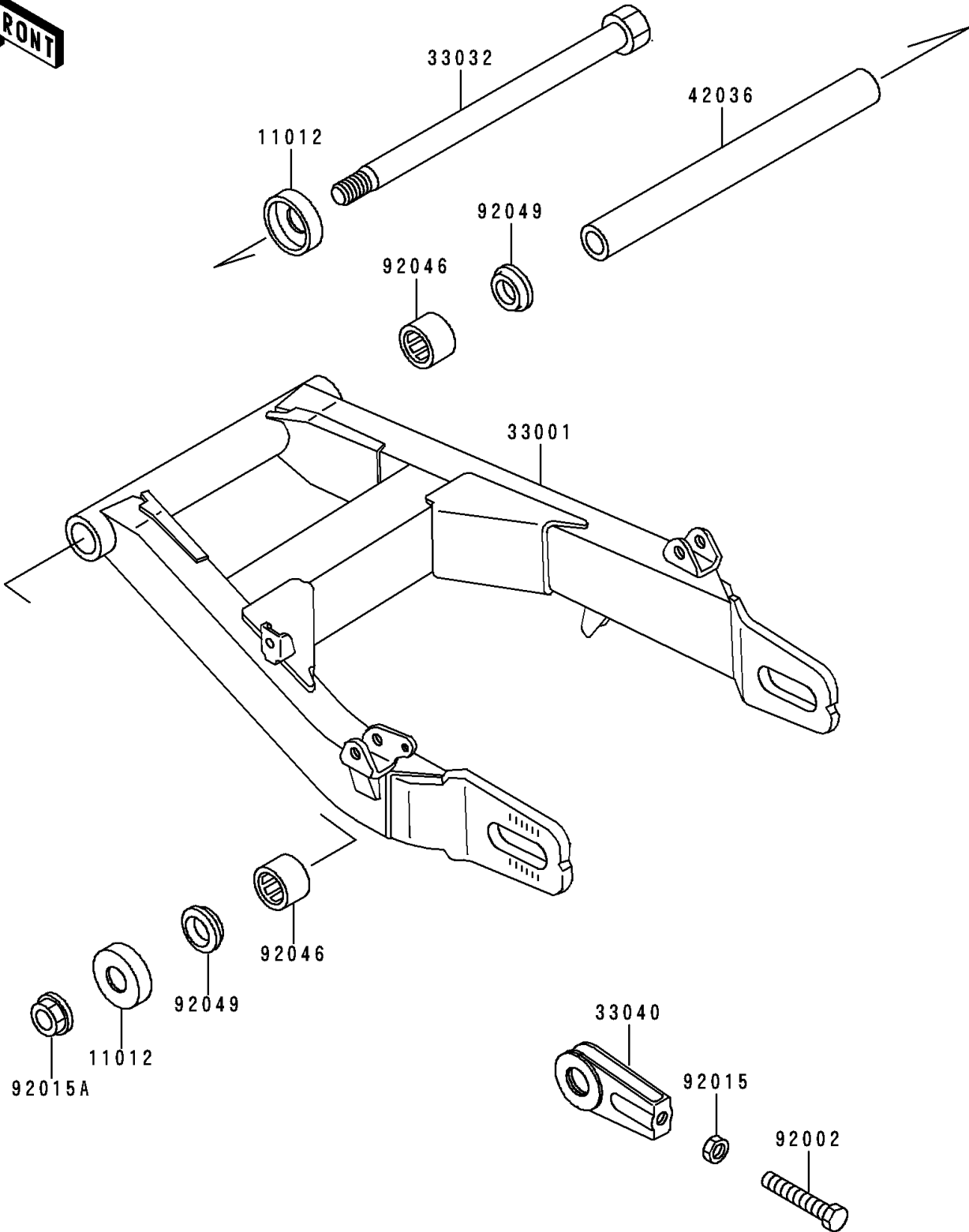

1990 Vulcan 500 PARTS LIST

Swingarm

ITEM NAME	PART NUMBER	QUANTITY
CAP,SWING ARM (Ref # 11012)	11012-1029	2
ARM-COMP-SWING,BLACK (Ref # 33001)	33001-1352-10	1
SHAFT-SWING ARM (Ref # 33032)	33032-1113	1
ADJUSTER-CHAIN (Ref # 33040)	33040-043	2
SLEEVE,SWING ARM (Ref # 42036)	42036-1018	1
BOLT,CHAIN ADJUSTER,8X50 (Ref # 92002)	92002-1076	2
NUT,8MM (Ref # 92015)	92015-1364	2
NUT,14MM (Ref # 92015A)	92015-1411	1
BEARING-NEEDLE,HK2216 (Ref # 92046)	92046-1115	2
SEAL-OIL,MHA22284 (Ref # 92049)	92049-1059	2