

1994 Vulcan 500 PARTS DIAGRAM

Battery Case

F2132

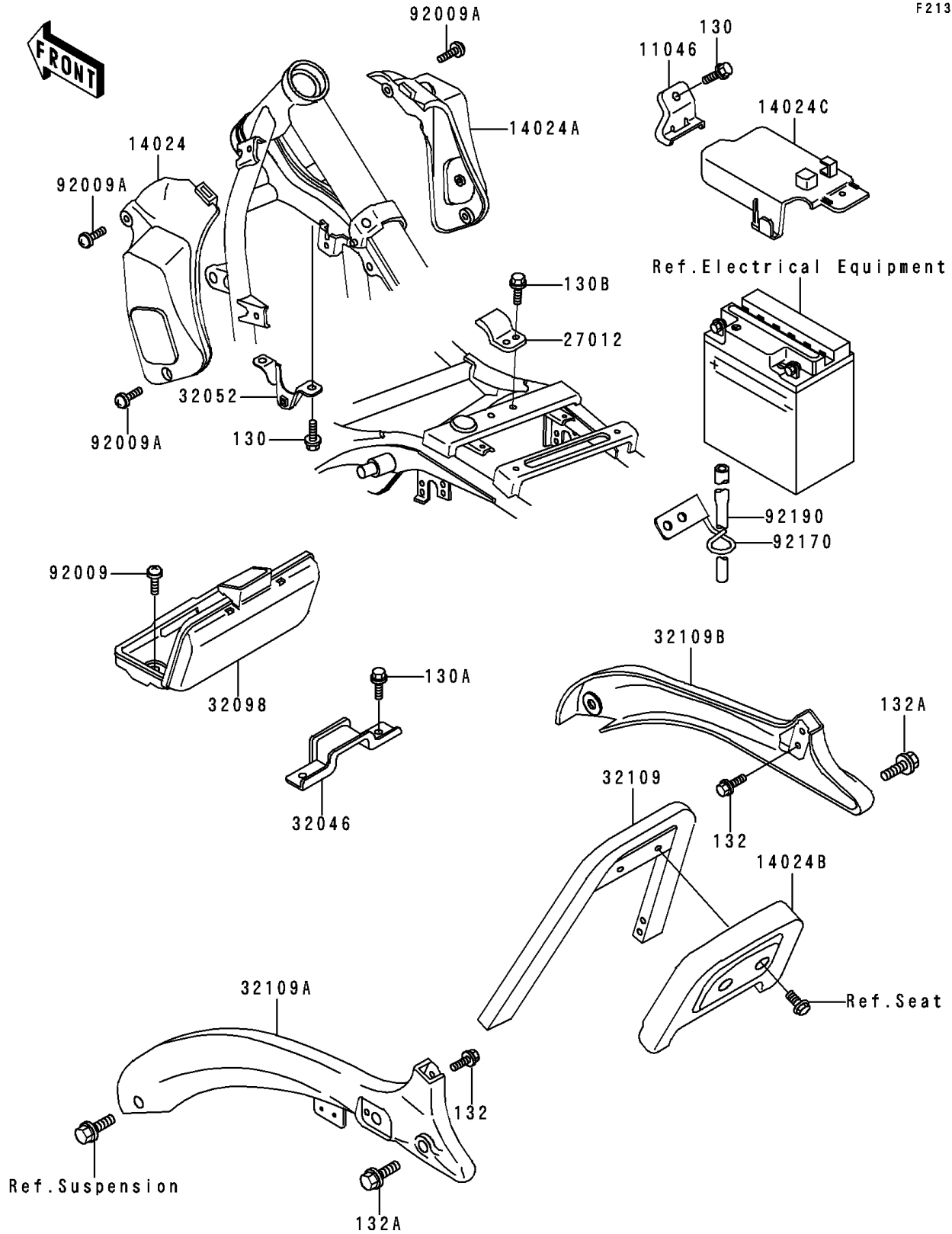

1994 Vulcan 500 PARTS LIST

Battery Case

ITEM NAME	PART NUMBER	QUANTITY
BOLT-FLANGED (Ref # 130)	130D0610	1
BOLT-FLANGED (Ref # 130A)	130D0620	1
BOLT-FLANGED,6X14,BLACK (Ref # 130B)	130J0614	1
BOLT-FLANGED-SMALL (Ref # 132)	132E0610	1
BOLT-FLANGED-SMALL (Ref # 132A)	132E0820	1
BRACKET,JUNCTION BOX (Ref # 11046)	11046-1915	1
COVER,HEAD GUSSET,LH (Ref # 14024)	14024-1105	1
COVER,HEAD GUSSET,RH (Ref # 14024A)	14024-1106	1
COVER,BACK REST (Ref # 14024B)	14024-1879	1
COVER,BATTERY (Ref # 14024C)	14024-1880	1
HOOK,SEAT (Ref # 27012)	27012-1429	1
BRACKET-SEAT,RR (Ref # 32046)	32046-1340	1
BRACKET-TANK (Ref # 32052)	32052-1179	1
CASE-TOOL (Ref # 32098)	32098-1052	1
GRIP-FRAME,UPP (Ref # 32109)	32109-1201	1
GRIP-FRAME,LH (Ref # 32109A)	32109-1213	1
GRIP-FRAME,RH (Ref # 32109B)	32109-1214	1
SCREW,6X22,BLACK (Ref # 92009)	92009-1256	1
SCREW,6X14 (Ref # 92009A)	92009-1288	1
CLAMP,HOSE (Ref # 92170)	92170-1181	1
TUBE,BATTERY VENT HOSE (Ref # 92190)	92190-1140	1