

1994 Vulcan 500 PARTS DIAGRAM

Frame Fittings

F2131

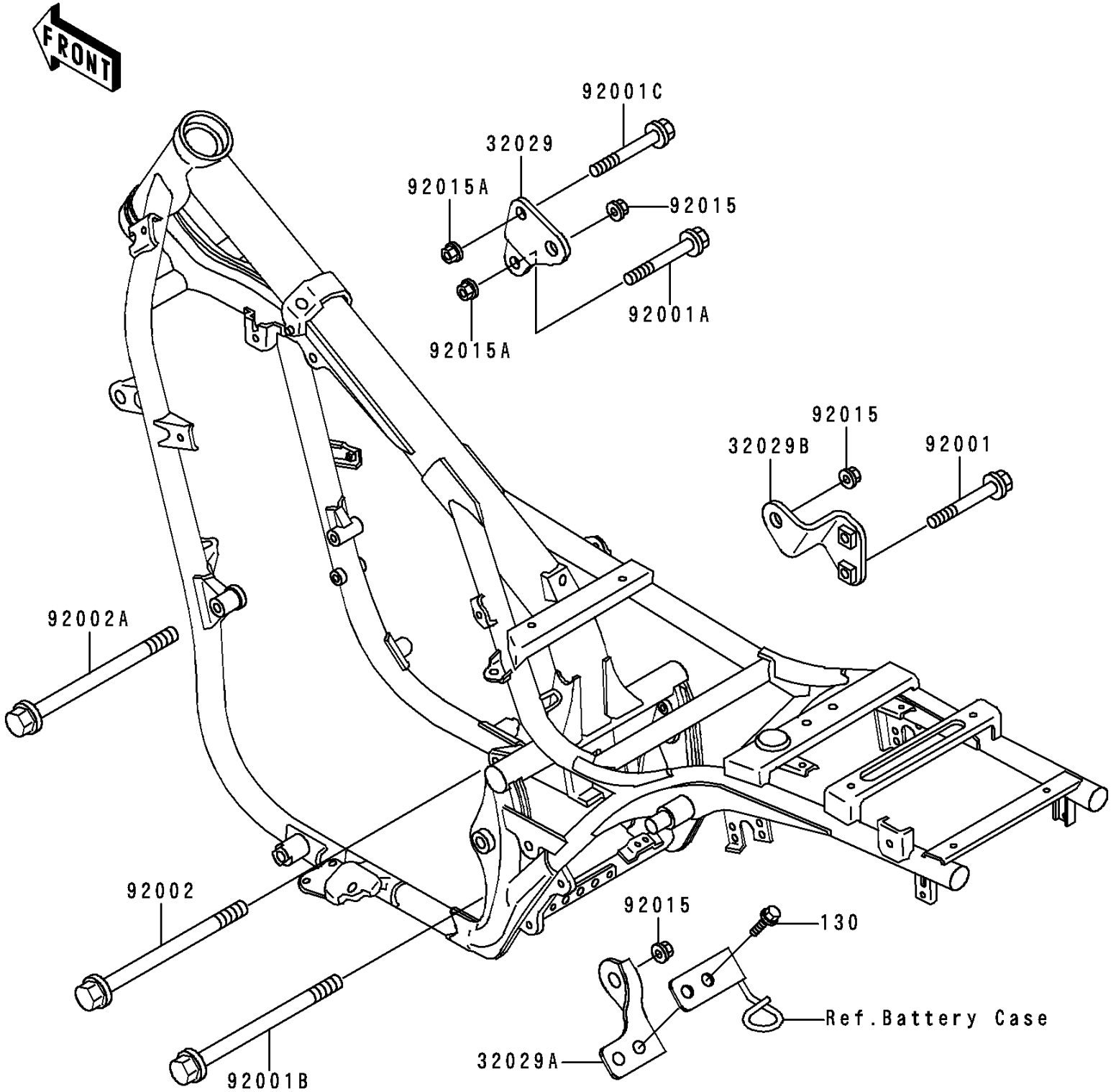

1994 Vulcan 500 PARTS LIST

Frame Fittings

ITEM NAME	PART NUMBER	QUANTITY
BOLT-FLANGED,8X16,BLACK (Ref # 130)	130J0816	1
BRACKET-ENGINE,FR,RH (Ref # 32029)	32029-1377	1
BRACKET-ENGINE,RR,LWR,RH (Ref # 32029A)	32029-1379	1
BRACKET-ENGINE,RR,UPP,RH (Ref # 32029B)	32029-1727	1
BOLT,FLANGED,8X45 (Ref # 92001)	92001-1613	1
BOLT,FLANGED,8X60,BLACK (Ref # 92001A)	92001-1615	1
BOLT,FLANGED,10X180 (Ref # 92001B)	92001-1621	1
BOLT,FLANGED,8X55,BLACK (Ref # 92001C)	92001-1641	1
BOLT,FLANGED,10X170 (Ref # 92002)	92002-1470	1
BOLT,FLANGED,10X230 (Ref # 92002A)	92002-1531	1
NUT,FLANGED,10MM (Ref # 92015)	92015-1180	1
NUT,FLANGED,8MM,BLACK (Ref # 92015A)	92015-1251	1