

1987 454 LTD PARTS DIAGRAM

Taillight(s)

F2720-0208

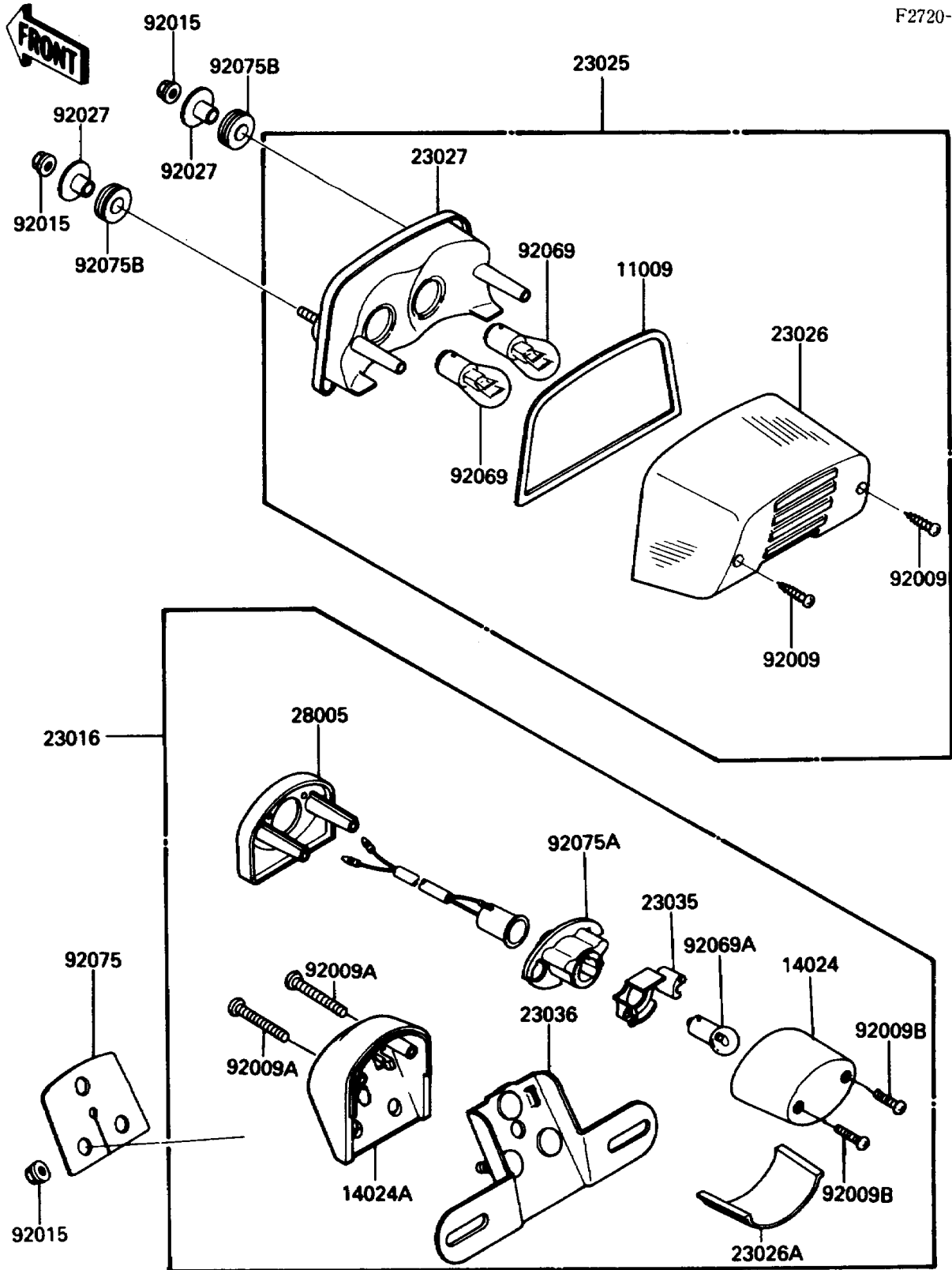

1987 454 LTD PARTS LIST

Taillight(s)

ITEM NAME	PART NUMBER	QUANTITY
GASKET,TAIL LAMP (Ref # 11009)	11009-1412	1
COVER,LICENSE LAMP (Ref # 14024)	14025-1725	1
COVER,LICENSE LAMP (Ref # 14024A)	14025-1728	1
LAMP-ASSY,LICENSE (Ref # 23016)	23016-1062	1
LAMP-TAIL (Ref # 23025)	23025-1117	1
LENS,TAIL LAMP (Ref # 23026)	23026-1062	1
LENS,LICENSE LAMP (Ref # 23026A)	23026-1064	1
BODY-COMP-TAIL LAMP (Ref # 23027)	23027-1057	1
REFLECTOR-LAMP,LICENSE (Ref # 23035)	23035-1060	1
BRACKET-TAIL LAMP (Ref # 23036)	23036-1105	1
BODY-LAMP,LICENSE (Ref # 28005)	28005-1051	1
SCREW,TAPPING,4X25 (Ref # 92009)	92009-1069	1
SCREW,TAPPING,5X40 (Ref # 92009A)	92009-1263	1
SCREW,TAPPING,4X20 (Ref # 92009B)	92009-1378	1
NUT,FLANGED,6MM (Ref # 92015)	92015-1367	1
COLLAR,L=13.1 (Ref # 92027)	92027-251	1
BULB,12V 27/8W (Ref # 92069)	92069-059	1
BULB,12V 8W (Ref # 92069A)	92069-1012	1
DAMPER,LICENSE LAMP (Ref # 92075)	92075-1676	1
DAMPER,LICENSE LAMP (Ref # 92075A)	92075-1694	1
DAMPER (Ref # 92075B)	92075-209	1