

1987 454 LTD PARTS DIAGRAM

Swingarm/Shock Absorber

F2140-0201

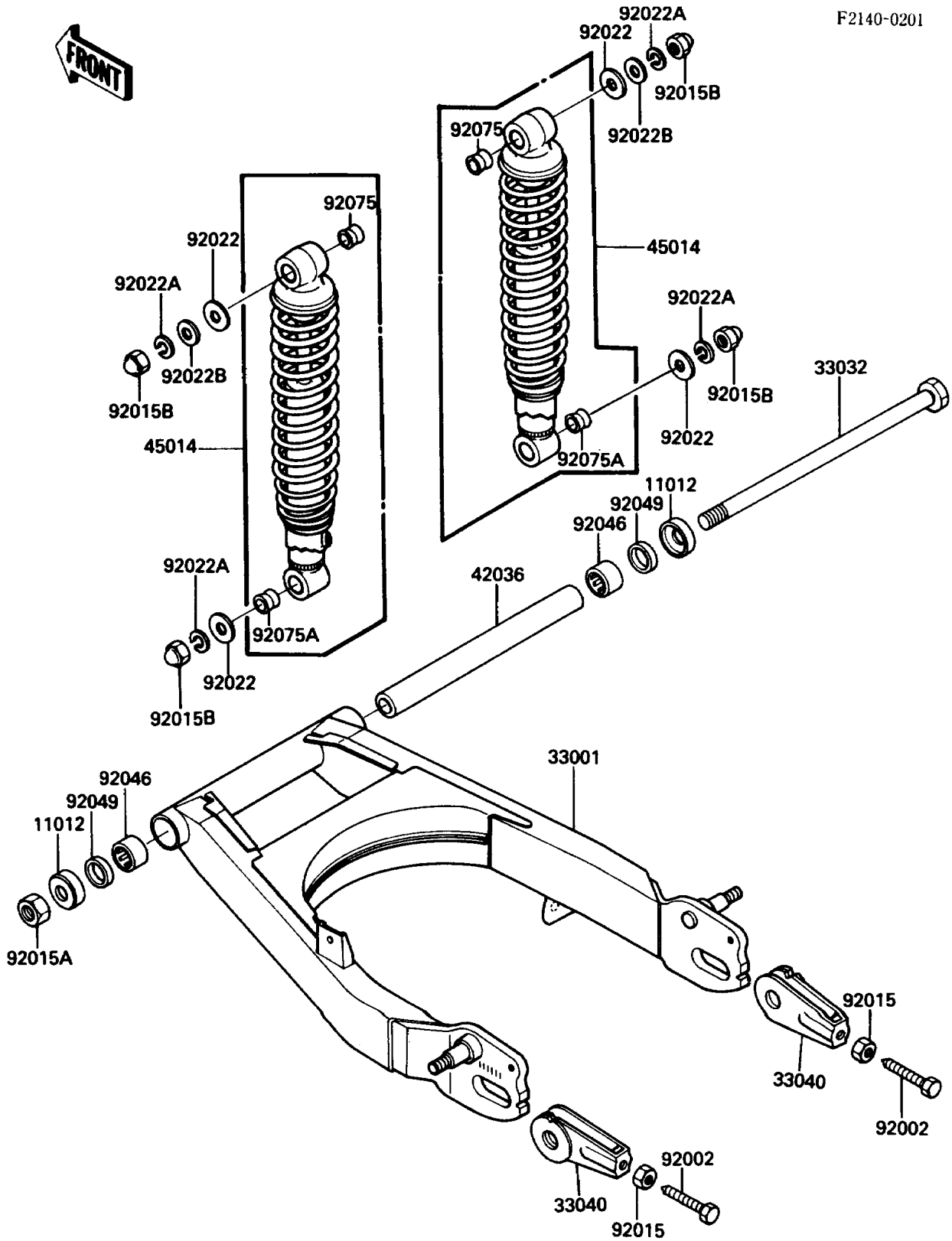

1987 454 LTD PARTS LIST

Swingarm/Shock Absorber

ITEM NAME	PART NUMBER	QUANTITY
CAP,SWING ARM (Ref # 11012)	11012-1029	1
ARM-COMP-SWING (Ref # 33001)	33001-1235	1
SHAFT-SWING ARM (Ref # 33032)	33032-1113	1
ADJUSTER-CHAIN (Ref # 33040)	33040-043	1
SLEEVE,SWING ARM (Ref # 42036)	42036-1018	1
SHOCKABSORBER (Ref # 45014)	45014-1305	1
BOLT,CHAIN ADJUSTER,8X50 (Ref # 92002)	92002-1076	1
NUT,8MM (Ref # 92015)	92015-1364	1
NUT,14MM (Ref # 92015A)	92015-1411	1
NUT,CAP,10MM (Ref # 92015B)	92020-003	1
WASHER,10.5X26X2.3 (Ref # 92022)	92022-044	1
WASHER,SPRING,10MM (Ref # 92022A)	92022-1540	1
WASHER,10.5X22X1.6 (Ref # 92022B)	92022-1558	1
BEARING-NEEDLE,HK2216 (Ref # 92046)	92046-1115	1
SEAL-OIL,MHA22284 (Ref # 92049)	92049-1059	1
DAMPER,SHOCKABSORBER (Ref # 92075)	45017-015	1
DAMPER,SHOCKABSORBER (Ref # 92075A)	92075-1387	1