

1989 454 LTD PARTS DIAGRAM

Ignition System

E1830-0228

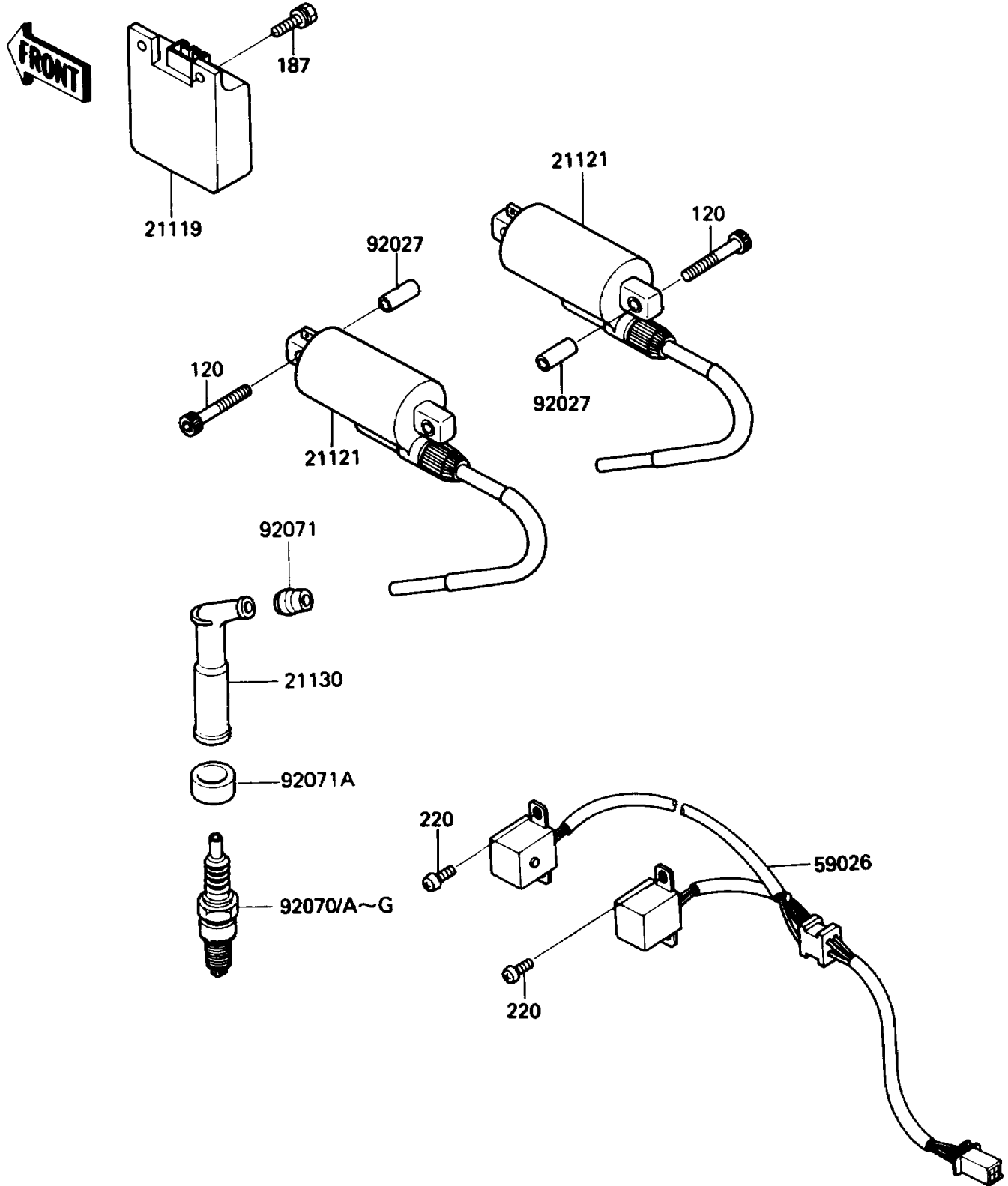

1989 454 LTD PARTS LIST

Ignition System

ITEM NAME	PART NUMBER	QUANTITY
IGNITER (Ref # 21119)	21119-1219	1
COIL-IGNITION (Ref # 21121)	21121-1130	2
CAP-SPARK PLUG (Ref # 21130)	21130-1002	2
COIL-PULSING (Ref # 59026)	59026-1066	1
COLLAR,6.8X10X23 (Ref # 92027)	92027-1870	4
PLUG-SPARK,X24ESR-U(ND) (Ref # 92070)		2
PLUG-SPARK,D8EA(NGK) (Ref # 92070A)	92070-1011	2
PLUG-SPARK,DR8ES(NGK) (Ref # 92070B)	92070-1019	2
PLUG-SPARK,X24ES-U(ND) (Ref # 92070C)		2
PLUG-SPARK,D9EA(NGK) (Ref # 92070D)	92070-1034	2
PLUG-SPARK,X27ES-U(ND) (Ref # 92070E)		2
PLUG-SPARK,X27ESR-U(ND) (Ref # 92070F)		2
PLUG-SPARK,DR8ES-L(NGK) (Ref # 92070G)	92070-1116	2
GROMMET,HIGH TENSION (Ref # 92071)	21131-005	2
GROMMET,PLUG CAP (Ref # 92071A)	92071-1124	2
BOLT-SOCKET,6X45 (Ref # 120)	120P0645	4
BOLT-UPSET-WSP (Ref # 187)	187G0616	2
SCREW-PAN-CROS (Ref # 220)	220B0510	4