

1987 454 LTD PARTS DIAGRAM

Fuel Evaporative System

E1650-0013

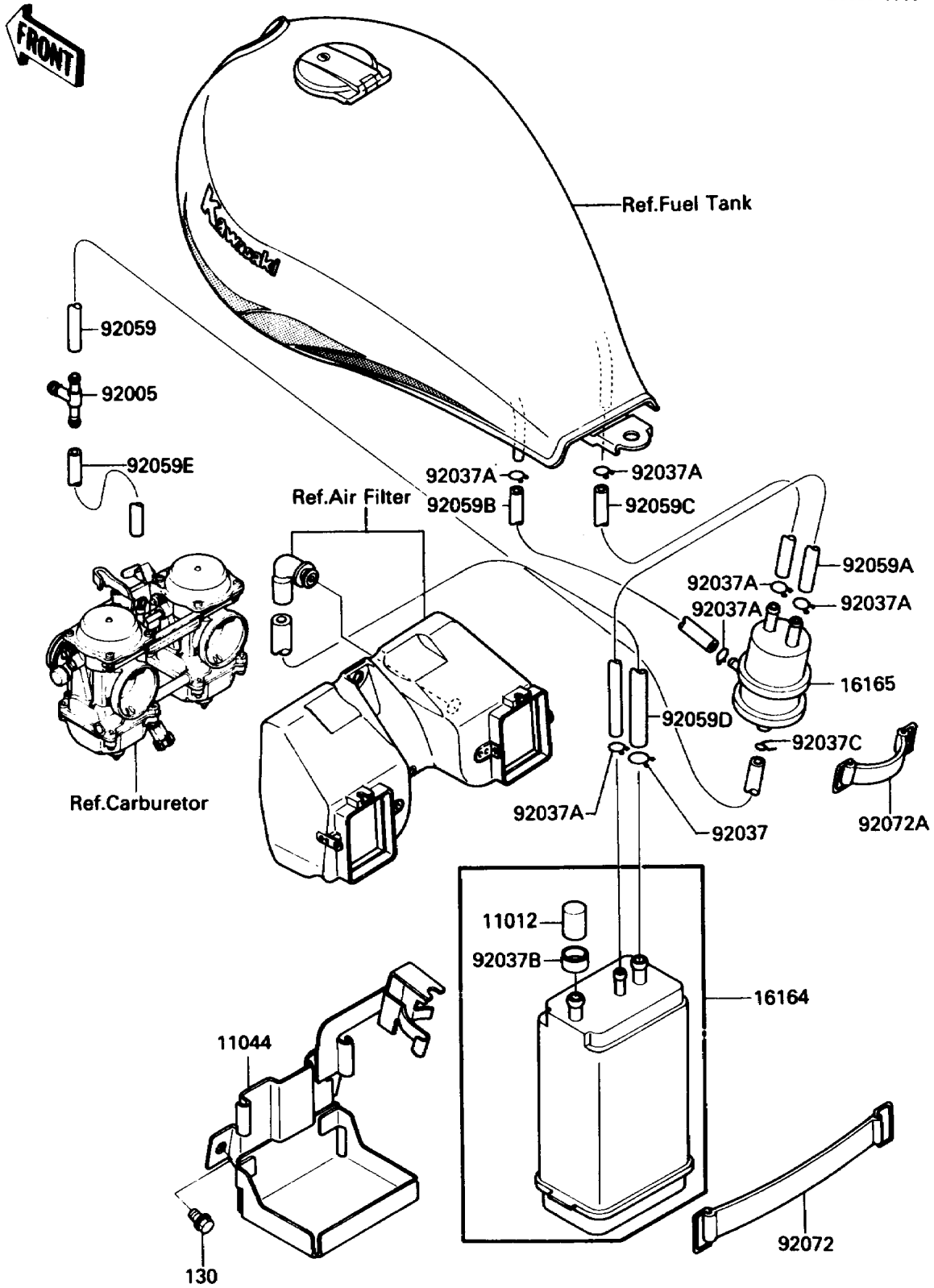

1987 454 LTD PARTS LIST

Fuel Evaporative System

ITEM NAME	PART NUMBER	QUANTITY
CAP,CANISTER (Ref # 11012)	11012-1388	1
BRACKET,CANISTER (Ref # 11044)	11043-1184	1
CANISTER (Ref # 16164)	16164-1054	1
SEPARATOR (Ref # 16165)	16165-1001	1
FITTING,TUBE,T-TYPE (Ref # 92005)	92005-1017	1
CLAMP,HOSE (Ref # 92037)	92037-1104	1
CLAMP,TUBE (Ref # 92037A)	92037-147	1
CLAMP,CANISTER (Ref # 92037B)	92037-1512	1
CLAMP (Ref # 92037C)	92037-1712	1
TUBE,4X9X650,WHITE (Ref # 92059)	92059-1405	1
TUBE,5X10X170,BLUE (Ref # 92059A)	92059-1496	1
TUBE,5X10X610,RED (Ref # 92059B)	92059-1526	1
TUBE,5X10X550,BLUE (Ref # 92059C)	92059-1589	1
TUBE,7X12X315,GREEN (Ref # 92059D)	92059-1590	1
TUBE,4X9X100,WHITE (Ref # 92059E)	92059-1591	1
BAND,L=142.1 (Ref # 92072)	92072-006	1
BAND,L=50 (Ref # 92072A)	92072-066	1
BOLT-FLANGED (Ref # 130)	130J0610	1