

1988 454 LTD PARTS DIAGRAM

Crankcase Bolt Pattern

E1412-0028

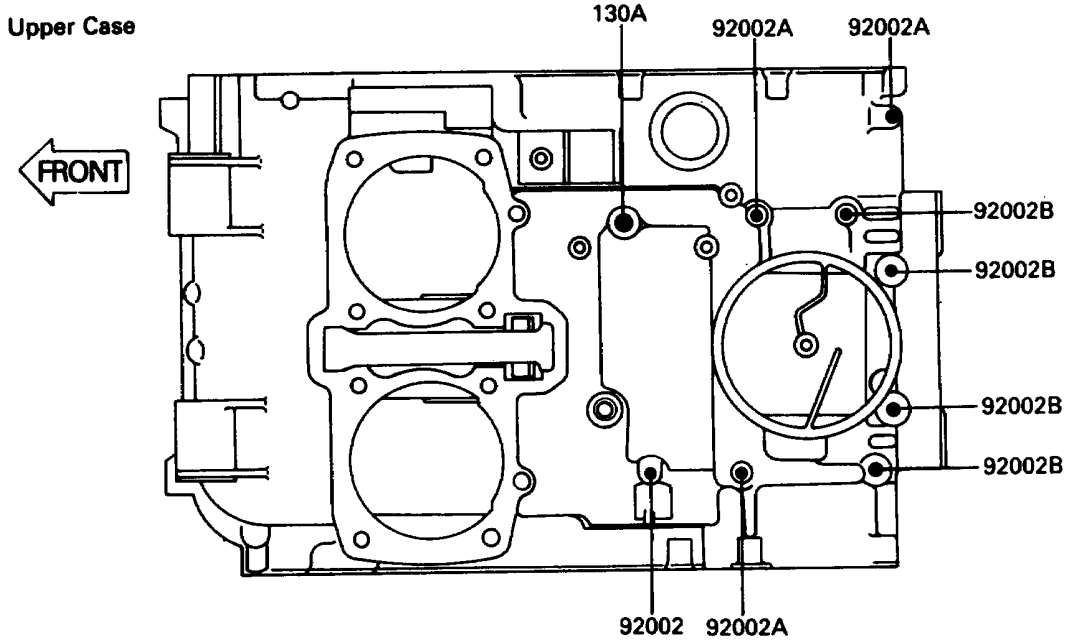

Lower Case

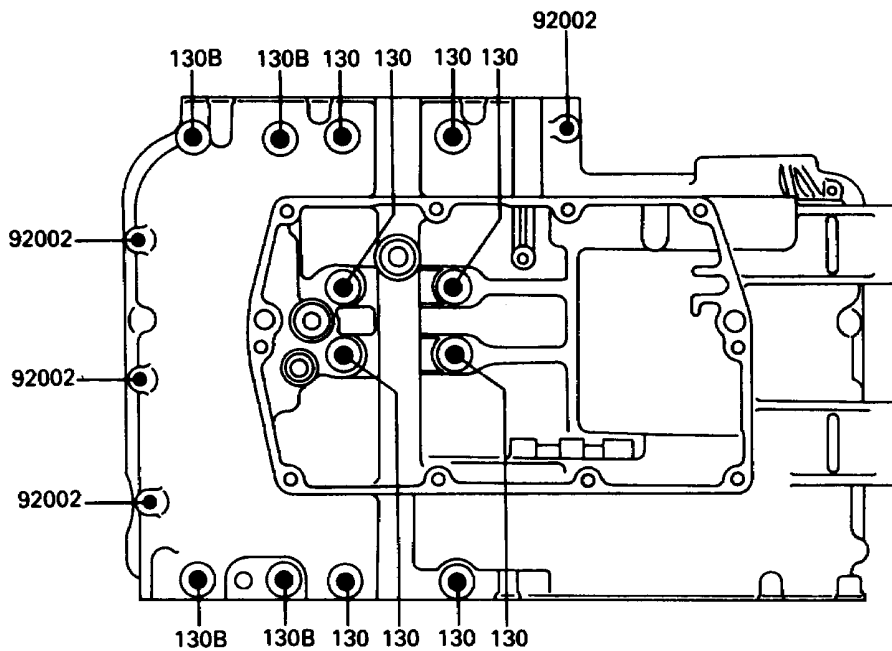

1988 454 LTD PARTS LIST

Crankcase Bolt Pattern

| ITEM NAME | PART NUMBER | QUANTITY |
|---------------------------|-------------|----------|
| BOLT,6X40 (Ref # 92002) | 92002-1566 | 1 |
| BOLT,6X60 (Ref # 92002A) | 92002-1567 | 1 |
| BOLT,6X80 (Ref # 92002B) | 92002-1568 | 1 |
| BOLT-FLANGED (Ref # 130) | 130Z08100 | 1 |
| BOLT-FLANGED (Ref # 130A) | 130Z0855 | 1 |
| BOLT-FLANGED (Ref # 130B) | 130Z0875 | 1 |