

1992 Eliminator 250 PARTS DIAGRAM

Handlebar

F2310

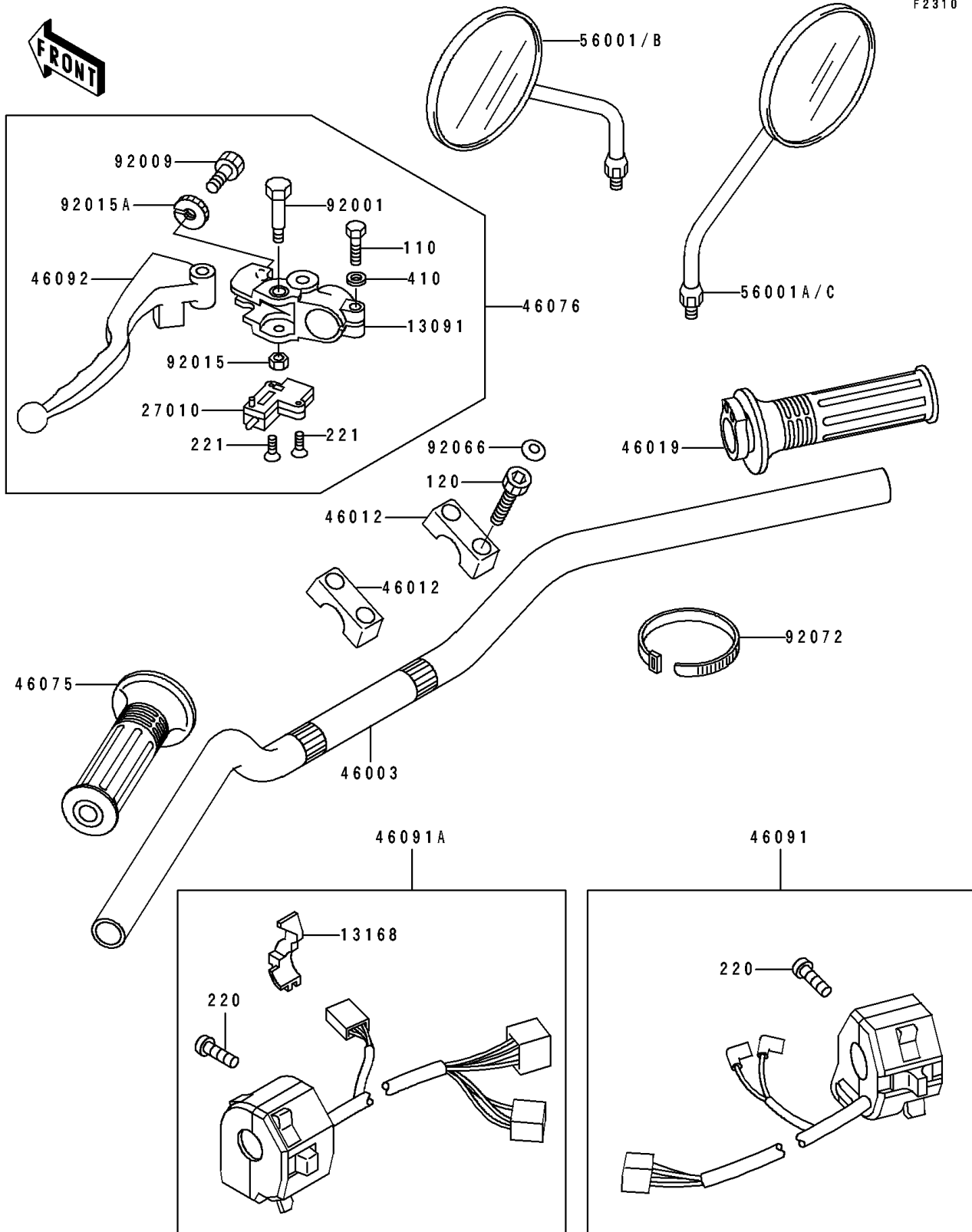

1992 Eliminator 250 PARTS LIST

Handlebar

ITEM NAME	PART NUMBER	QUANTITY
HOLDER,CLUTCH LEVER (Ref # 13091)	13091-1272	1
LEVER,CHOKE (Ref # 13168)	13168-1374	1
SWITCH,CLUTCH,BLACK (Ref # 27010)	27010-1094	1
HANDLE (Ref # 46003)	46003-1328	1
HOLDER-HANDLE (Ref # 46012)	46012-1137	1
GRIP-ASSY,THROTTLE (Ref # 46019)	46019-1061	1
GRIP,LH (Ref # 46075)	46075-1060	1
LEVER-ASSY-GRIP,CLUTCH (Ref # 46076)	46076-1105	1
HOUSING-ASSY-CONTROL,RH (Ref # 46091)	46091-1460	1
HOUSING-ASSY-CONTROL,LH (Ref # 46091A)	46091-1545	1
LEVER-GRIP,CLUTCH (Ref # 46092)	46092-1103	1
MIRROR-ASSY,LH (Ref # 56001)	56001-1023	1
MIRROR-ASSY,RH (Ref # 56001A)	56001-1024	1
BOLT,CLUTCH LEVER,BLACK (Ref # 92001)	92001-1548	1
SCREW,CABLE ADJUST,8MM,BLACK (Ref # 92009)	92009-1134	1
NUT,LOCK,6MM,BLACK (Ref # 92015)	92015-1191	1
NUT,CABLE ADJUST LOCK,BLACK (Ref # 92015A)	92015-1197	1
PLUG (Ref # 92066)	92066-1281	1
BAND,L=123 (Ref # 92072)	92072-030	1
BOLT,6X22,BLACK (Ref # 110)	110C0622	1
BOLT-SOCKET,8X30,BLACK (Ref # 120)	120S0830	1
SCREW-PAN-CROS (Ref # 220)	220C0520	1
SCREW-CSK-CROS (Ref # 221)	221C0316	1
WASHER-PLAIN-SMALL,6MM,BLACK (Ref # 410)	410F0600	1