

1992 Eliminator 250 PARTS DIAGRAM

Brake Pedal/Torque Link

F2260

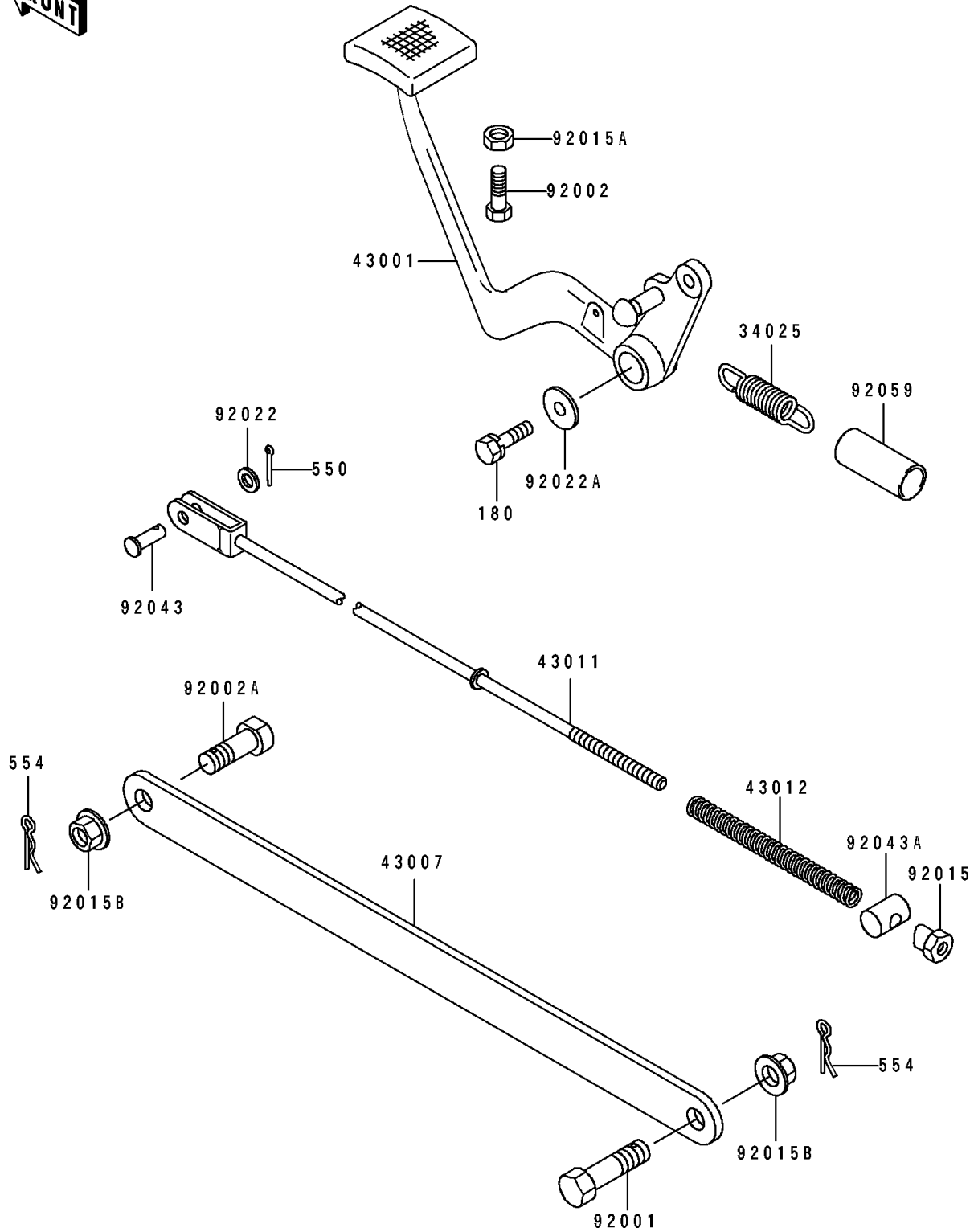

1992 Eliminator 250 PARTS LIST

Brake Pedal/Torque Link

ITEM NAME	PART NUMBER	QUANTITY
SPRING,SIDE STAND (Ref # 34025)	34025-009	1
LEVER-BRAKE,PEDAL (Ref # 43001)	43001-1234	1
ROD-TORQUE,RR (Ref # 43007)	43007-1026	1
ROD-BRAKE (Ref # 43011)	43011-1141	1
SPRING,BRAKE ROD (Ref # 43012)	43012-001	1
BOLT,10X37 (Ref # 92001)	92001-1519	1
BOLT,6X20 (Ref # 92002)	92002-1373	1
BOLT,ROD,10X27 (Ref # 92002A)	92002-1992	1
NUT,BRAKE ROD (Ref # 92015)	92015-042	1
NUT,6MM (Ref # 92015A)	92015-1391	1
NUT,FLANGED,10MM (Ref # 92015B)	92015-1428	2
WASHER,6.5X11.5X0.8 (Ref # 92022)	92022-1556	1
WASHER,6.5X20X1.6 (Ref # 92022A)	92022-1557	1
PIN,6X17 (Ref # 92043)	92043-064	1
PIN,BRAKE ROD (Ref # 92043A)	92043-065	1
TUBE,14X17X40 (Ref # 92059)	92059-1983	1
BOLT-UPSET-WS (Ref # 180)	180D0616	1
PIN-COTTER,2.0X15 (Ref # 550)	550D2015	1
PIN-SNAP,8MM (Ref # 554)	554A0800	2