

1992 Eliminator 250 PARTS DIAGRAM

Generator

E1810

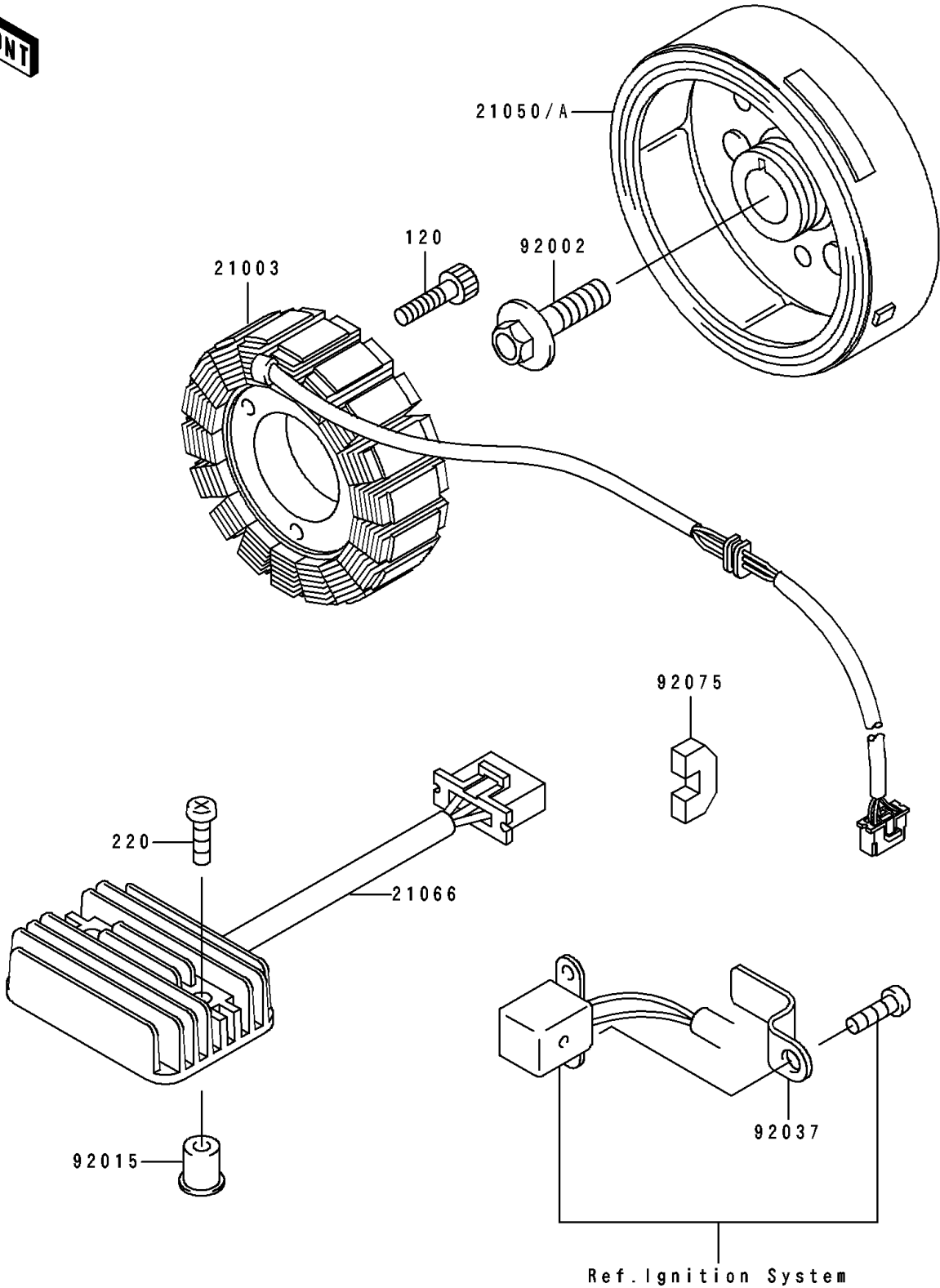

1992 Eliminator 250 PARTS LIST

Generator

ITEM NAME	PART NUMBER	QUANTITY
STATOR (Ref # 21003)	21003-1154	1
FLYWHEEL (Ref # 21050)	21050-1129	1
REGULATOR-VOLTAGE (Ref # 21066)	21066-1030	1
BOLT,10X28 (Ref # 92002)	92002-1688	1
NUT (Ref # 92015)	92015-1700	1
CLAMP (Ref # 92037)	92037-1919	1
DAMPER (Ref # 92075)	92075-1811	1
BOLT-SOCKET,6X25 (Ref # 120)	120P0625	1
SCREW-PAN-CROS,6X30 (Ref # 220)	220B0630	1