

1992 Eliminator 250 PARTS DIAGRAM

Gear Change Mechanism

E1370

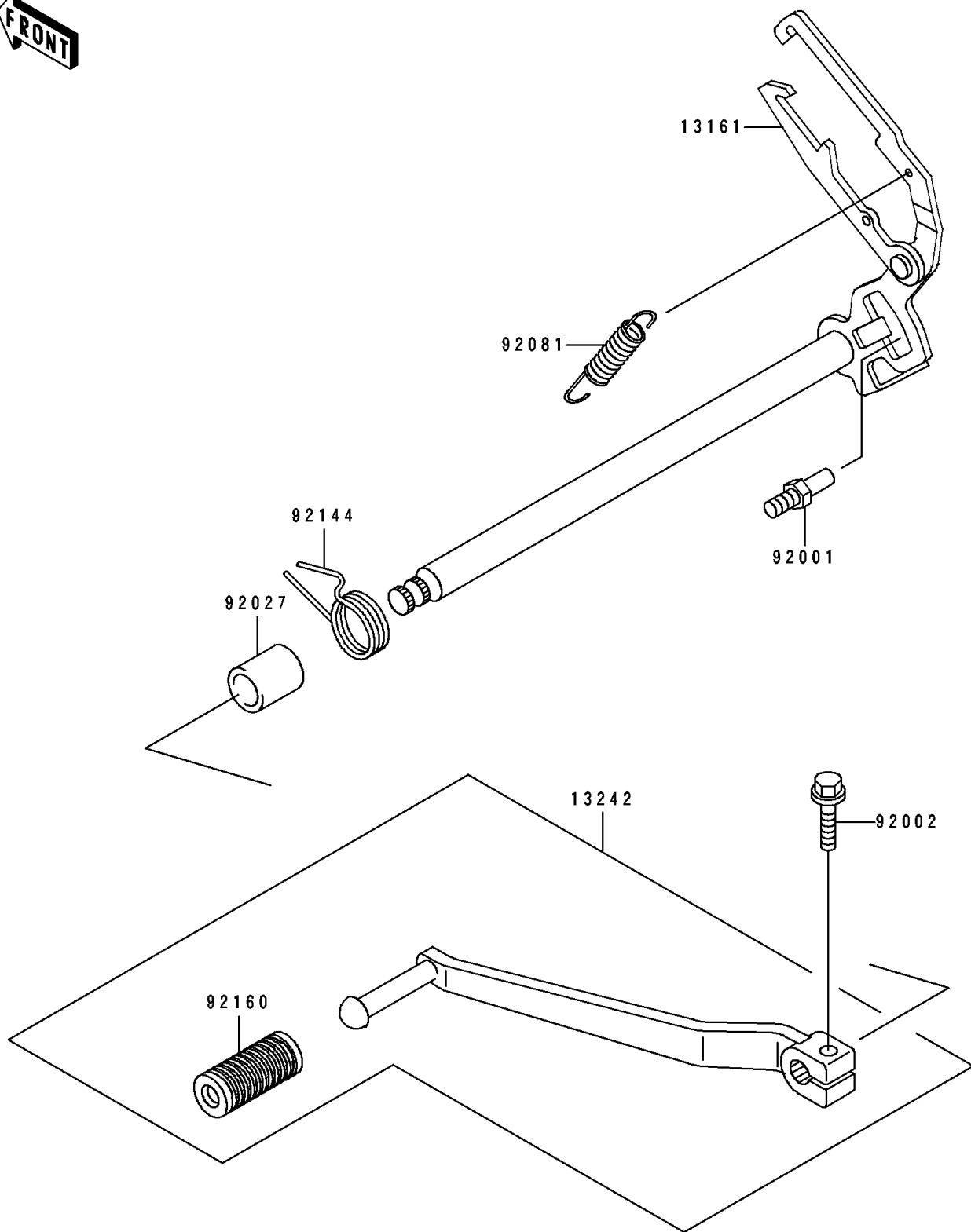

1992 Eliminator 250 PARTS LIST

Gear Change Mechanism

ITEM NAME	PART NUMBER	QUANTITY
LEVER-COMP-CHANGE SHAFT (Ref # 13161)	13161-1131	1
LEVER-ASSY-CHANGE,PEDAL (Ref # 13242)	13242-1238	1
BOLT,RETURN SPRING (Ref # 92001)	92001-1455	1
BOLT,6X20 (Ref # 92002)	92002-1237	1
COLLAR,13X18.3X21.5 (Ref # 92027)	92027-1440	1
SPRING,CHANGE LEVER (Ref # 92081)	92081-076	1
SPRING,CHANGE PEDAL RETURN (Ref # 92144)	92144-1074	1
DAMPER,CHANGE PEDAL (Ref # 92160)	92160-1036	1