

1988 Eliminator PARTS DIAGRAM

Side Covers/Chain Cover

F2610-0356

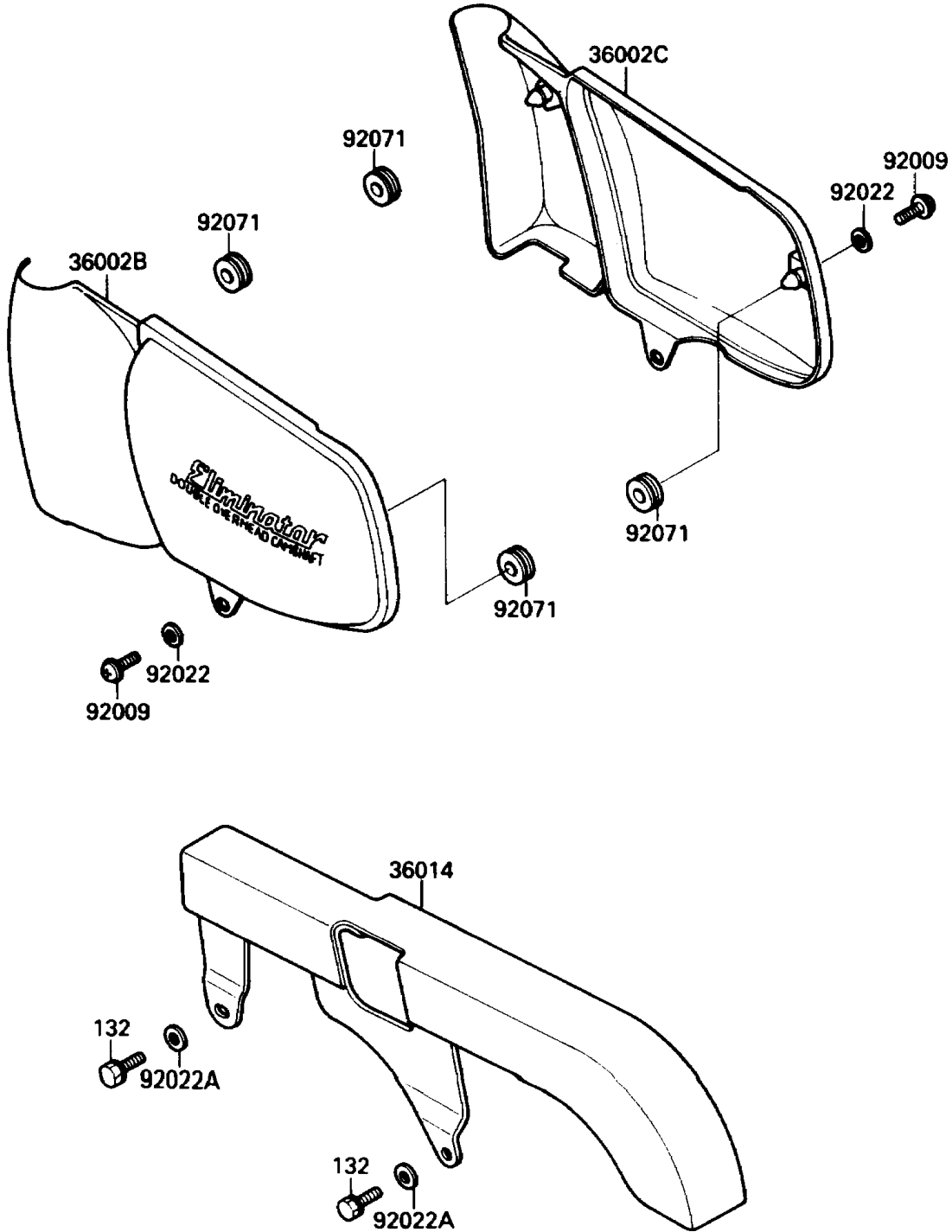

1988 Eliminator PARTS LIST

Side Covers/Chain Cover

ITEM NAME	PART NUMBER	QUANTITY
COVER-SIDE,LH,EBONY/CR PLATING (Ref # 36002B)	36002-5425-Y8	1
COVER-SIDE,RH,EBONY/CR PLATING (Ref # 36002C)	36002-5426-Y8	1
CASE-CHAIN (Ref # 36014)	36014-1148	1
SCREW,6X14,WHITE (Ref # 92009)	92009-1287	2
WASHER,6.5X16X1.0 (Ref # 92022)	92022-1654	2
WASHER,6.5X20X1.6,WHITE (Ref # 92022A)	92022-193	2
GROMMET (Ref # 92071)	92071-056	4
BOLT-FLANGED-SMALL,6X14 (Ref # 132)	132E0614	2