

1988 Eliminator PARTS DIAGRAM

Cylinder/Piston(s)

E1120-0083

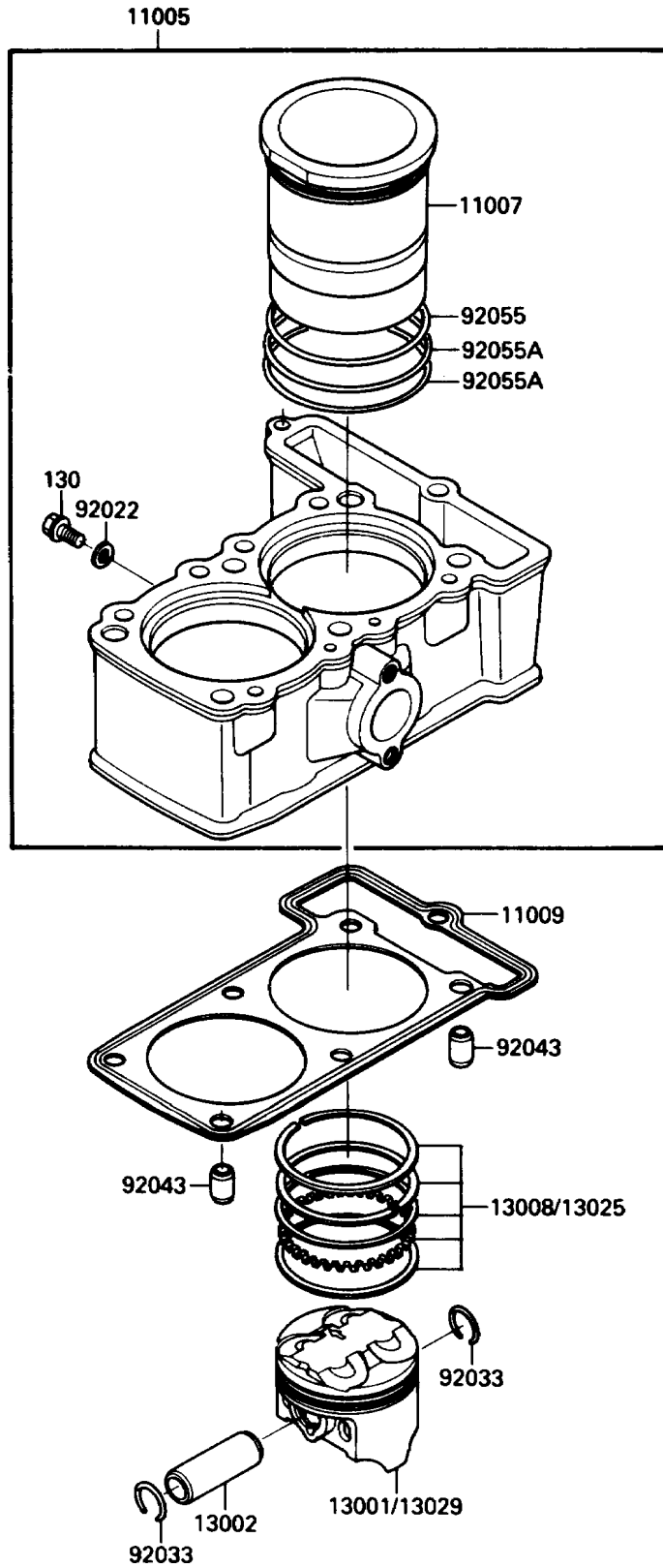

1988 Eliminator PARTS LIST

Cylinder/Piston(s)

ITEM NAME	PART NUMBER	QUANTITY
CYLINDER-ENGINE (Ref # 11005)	11005-1489	1
LINER-CYLINDER (Ref # 11007)	11007-1085	2
GASKET,CYLINDER BASE (Ref # 11009)	11009-1572	1
PISTON-ENGINE,STD (Ref # 13001)	13001-1265	2
PIN-PISTON (Ref # 13002)	13002-1062	2
RING-SET-PISTON,STD (Ref # 13008)	13008-1072	2
RING-SET-PISTON L,O/S 0.50 (Ref # 13025)	13025-1074	2
PISTON-ENGINE L,O/S 0.50 (Ref # 13029)	13029-1163	2
WASHER,6.2X11X1 (Ref # 92022)	92022-304	1
RING-SNAP,PISTON PIN (Ref # 92033)	92033-1161	4
PIN,8.2X10X14 (Ref # 92043)	92043-1264	2
RING-O,67.5MM (Ref # 92055)	92055-1035	2
RING-O,68.2X2.4 (Ref # 92055A)	92055-1338	4
BOLT-FLANGED,6X10,BLACK (Ref # 130)	130C0610	1