

2001 W650 PARTS DIAGRAM

Clutch

E1350

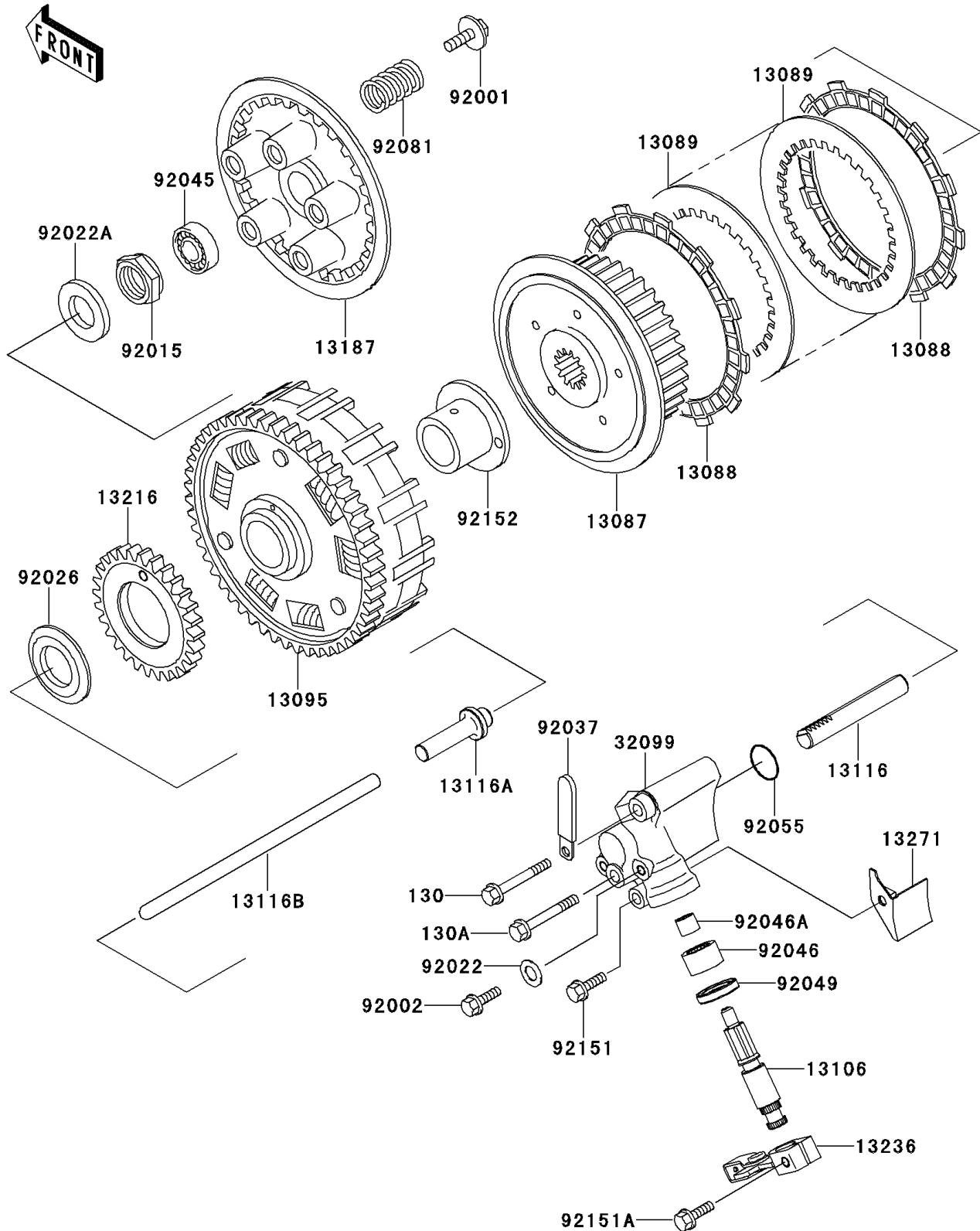

2001 W650 PARTS LIST

Clutch

ITEM NAME	PART NUMBER	QUANTITY
BOLT-FLANGED (Ref # 130)	130Z0670	1
BOLT-FLANGED (Ref # 130A)	130Z0680	1
HUB-CLUTCH (Ref # 13087)	13087-042	1
PLATE-FRICTION (Ref # 13088)	13088-1133	1
PLATE-CLUTCH (Ref # 13089)	13089-027	1
HOUSING-COMP-CLUTCH (Ref # 13095)	13095-1378	1
SHAFT-CLUTCH RELEASE (Ref # 13106)	13106-1068	1
ROD-PUSH,RELEASE POSITION (Ref # 13116)	13116-1163	1
ROD-PUSH,CLUTCH POSITION (Ref # 13116A)	13116-1164	1
ROD-PUSH,MIDDLE POSITION (Ref # 13116B)	13116-1165	1
PLATE-CLUTCH OPERATING (Ref # 13187)	13187-1006	1
GEAR-COMP,OIL PUMP (Ref # 13216)	13216-1177	1
LEVER-COMP,CLUTCH RELEASE (Ref # 13236)	13236-1331	1
PLATE (Ref # 13271)	13271-1179	1
CASE,CLUTCH RELEASE (Ref # 32099)	32099-1204	1
BOLT,FLANGED,6X18 (Ref # 92001)	92001-1066	1
BOLT (Ref # 92002)	92002-1357	1
NUT,20MM (Ref # 92015)	92015-1555	1
WASHER,6.1X12X1 (Ref # 92022)	92022-077	1
WASHER (Ref # 92022A)	92022-1868	1
SPACER (Ref # 92026)	92026-1242	1
CLAMP,L=45 (Ref # 92037)	92037-1539	1
BEARING-BALL,6001C3ML01 (Ref # 92045)	92045-1235	1
BEARING-NEEDLE,7E-HK1412 (Ref # 92046)	92046-037	1
BEARING-NEEDLE,HK0709 (Ref # 92046A)	92046-1142	1
SEAL-OIL,TC14245 (Ref # 92049)	92049-1520	1
RING-O,16.8X1.9 (Ref # 92055)	92055-1598	1
SPRING,CLUTCH (Ref # 92081)	92081-1864	1
BOLT,6X40 (Ref # 92151)	92151-1131	1

2001 W650 PARTS LIST

Clutch

ITEM NAME	PART NUMBER	QUANTITY
BOLT,6X20 (Ref # 92151A)	92151-1226	1
COLLAR,CLUTCH GEAR (Ref # 92152)	92152-1146	1