

2009 MULE™ 4010 4x4 PARTS DIAGRAM

Crankshaft/Piston(s)

E1320

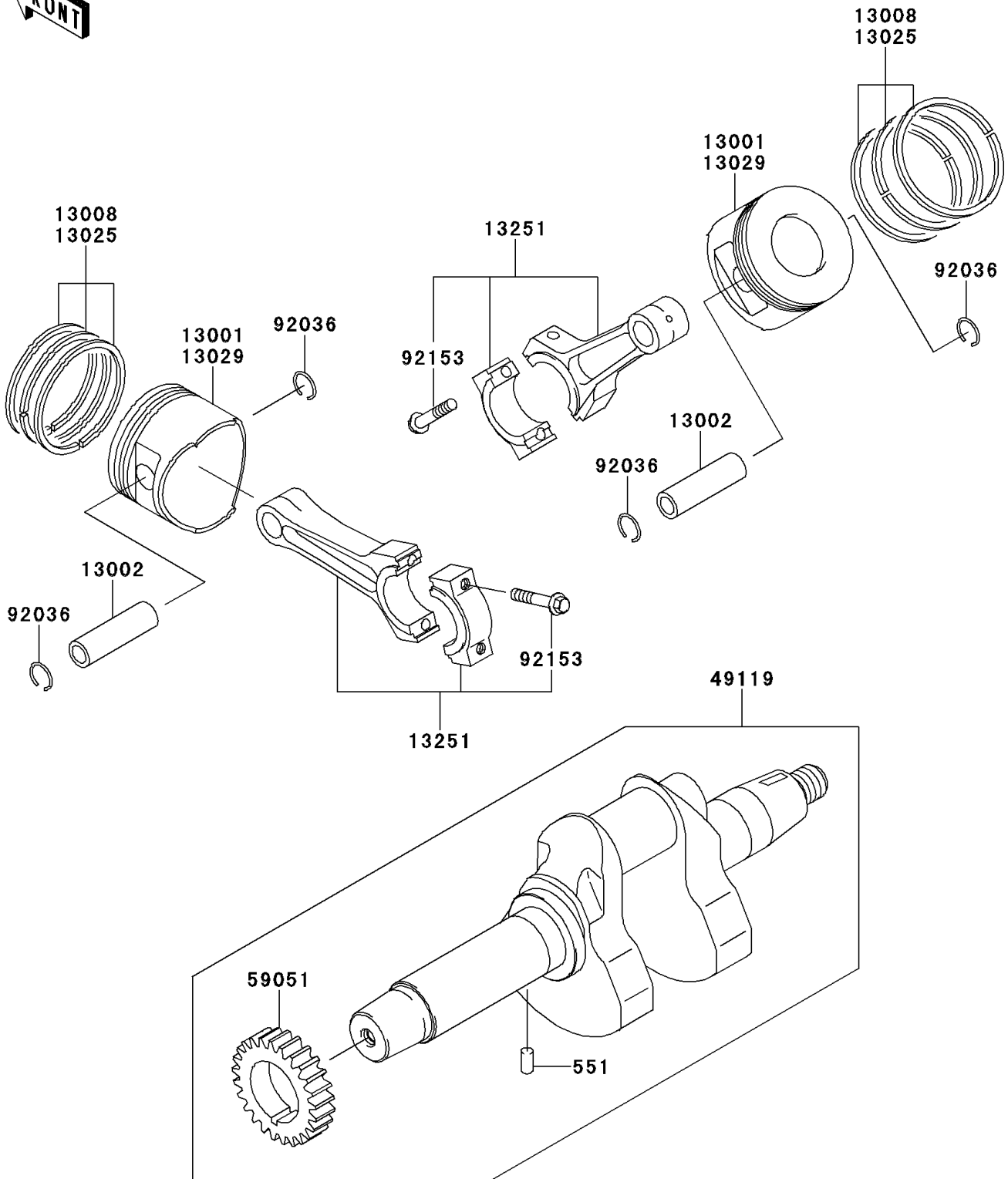

2009 MULE™ 4010 4x4 PARTS LIST

Crankshaft/Piston(s)

ITEM NAME	PART NUMBER	QUANTITY
PIN-DOWEL,4X8 (Ref # 551)	551A0408	1
PISTON-ENGINE,STD (Ref # 13001)	13001-2196	1
PIN-PISTON (Ref # 13002)	13002-1013	1
RING-SET-PISTON,STD (Ref # 13008)	13008-6025	1
RING-SET-PISTON L,0.50 (Ref # 13025)	13025-6008	1
PISTON-ENGINE L,0.50 (Ref # 13029)	13029-2141	1
ROD-ASSY-CONNECTING (Ref # 13251)	13251-2086	1
CRANKSHAFT-ASSY (Ref # 49119)	49119-2200	1
GEAR-SPUR (Ref # 59051)	59051-2112	1
RING-SNAP,PISTON PIN (Ref # 92036)	92036-021	1
BOLT,7X35.2 (Ref # 92153)	92153-2054	1