

2011 KX™450F PARTS DIAGRAM

Brake Pedal

F2260

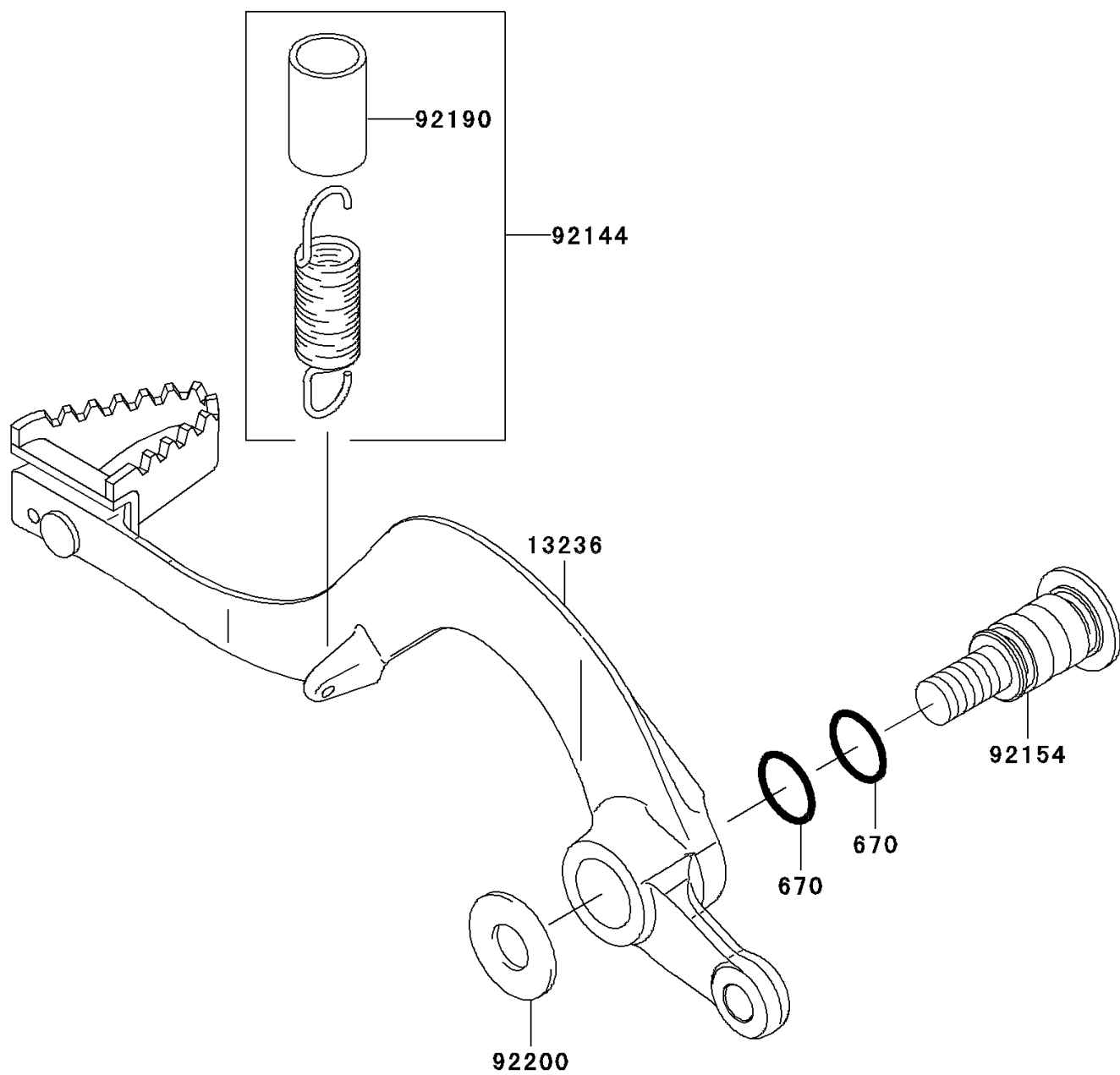

2011 KX™450F PARTS LIST

Brake Pedal

ITEM NAME	PART NUMBER	QUANTITY
O RING,12MM (Ref # 670)	670B2012	1
LEVER-COMP,BRAKE PEDAL (Ref # 13236)	13236-0086	1
SPRING,BRAKE PEDAL RETURN (Ref # 92144)	92144-1752	1
BOLT,BRAKE PEDAL,10MM (Ref # 92154)	92154-0516	1
TUBE,13X16X25 (Ref # 92190)	92190-1488	1
WASHER,10.5X24X1.5 (Ref # 92200)	92200-0154	1