

2010 Concours® 14 ABS PARTS DIAGRAM

Meter(s)

F2530

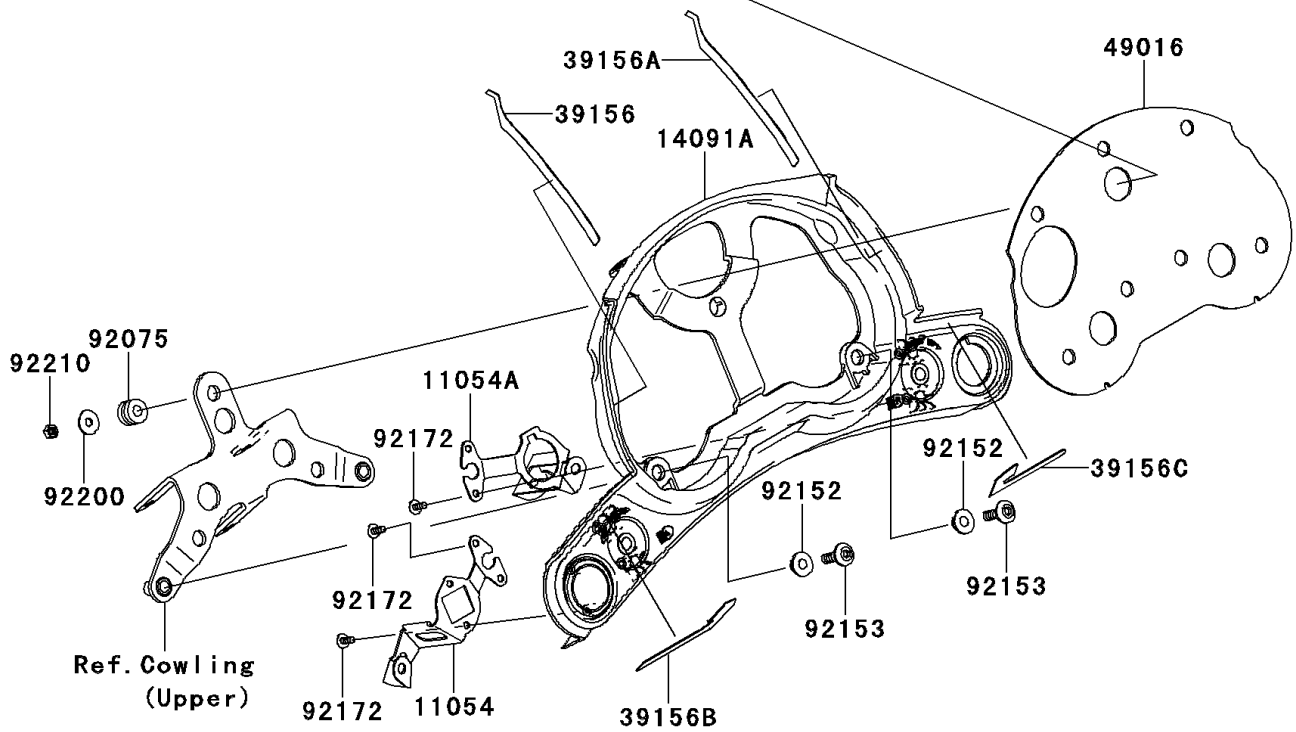
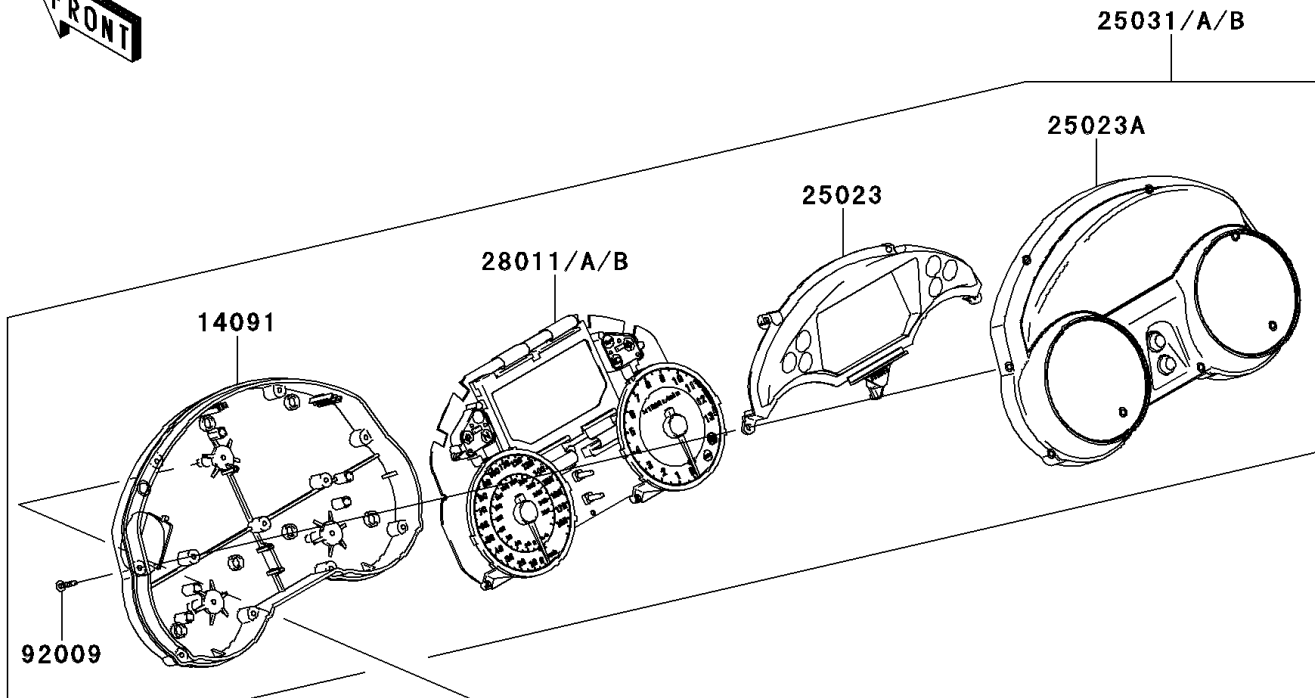

2010 Concours® 14 ABS PARTS LIST

Meter(s)

ITEM NAME	PART NUMBER	QUANTITY
BRACKET,METER COVER,LH (Ref # 11054)	11054-1786	1
BRACKET,METER COVER,RH (Ref # 11054A)	11054-1787	1
COVER,METER,LWR (Ref # 14091)	14091-0546	1
COVER,METER (Ref # 14091A)	14091-0890	1
COVER-METER CASE,VISOR (Ref # 25023)	25023-0021	1
COVER-METER CASE,UPP (Ref # 25023A)	25023-0034	1
PAD,METER COVER,LH (Ref # 39156)	39156-0374	1
PAD,METER COVER,RH (Ref # 39156A)	39156-0375	1
PAD,METER COVER,LH (Ref # 39156B)	39156-0376	1
PAD,METER COVER,RH (Ref # 39156C)	39156-0377	1
COVER-SEAL,SPEEDOMETER (Ref # 49016)	49016-0046	1
SCREW,TAPPING,3X16 (Ref # 92009)	92009-1164	1
DAMPER (Ref # 92075)	92075-1435	1
COLLAR (Ref # 92152)	92152-0445	1
BOLT,SOCKET,6X22 (Ref # 92153)	92153-0574	1
SCREW,TAPPING,4X10 (Ref # 92172)	92172-0172	1
WASHER (Ref # 92200)	92200-0288	1
NUT,5MM (Ref # 92210)	92210-0290	1
METER-ASSY,SPEED&TACHO&LCD (Ref # 25031)	25031-0294	1
METER-ASSY,SPEED&TACHO&LCD (Ref # 25031A)	25031-0300	1
METER,SPEED&TACHO&LCD (Ref # 28011)	28011-0156	1
METER,SPEED&TACHO&LCD (Ref # 28011A)	28011-0162	1