

## 2008 KX™250F PARTS DIAGRAM

Footrests

F2160

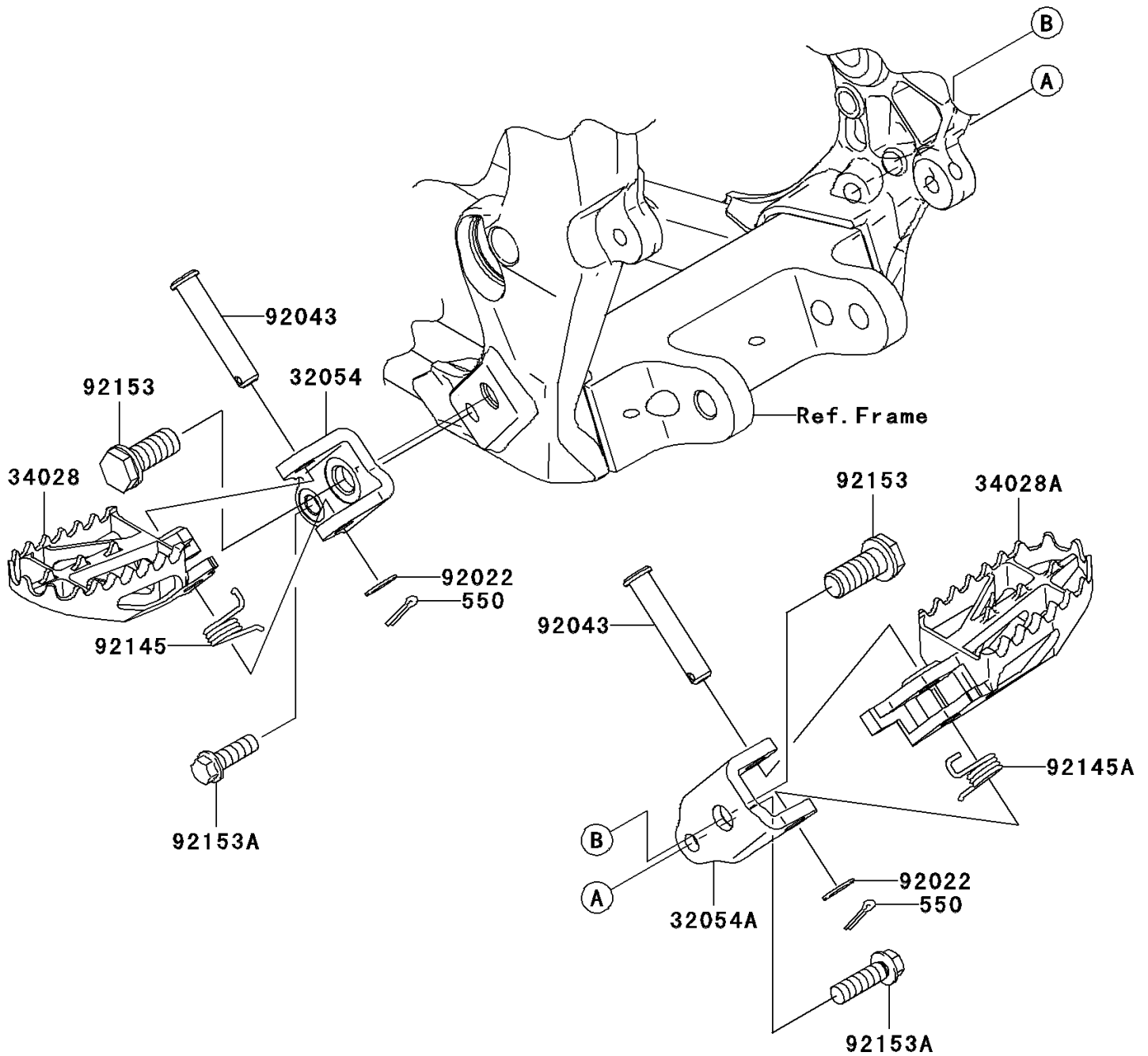

## 2008 KX™250F PARTS LIST

Footrests

ITEM NAME	PART NUMBER	QUANTITY
PIN-COTTER,3.0X20 (Ref # 550)	550S3020	1
BRACKET-STEP,LH (Ref # 32054)	32054-0020	1
BRACKET-STEP,RH (Ref # 32054A)	32054-0021	1
STEP,LH (Ref # 34028)	34028-0014	1
STEP,RH (Ref # 34028A)	34028-0015	1
WASHER,10.2X16X1 (Ref # 92022)	92022-1829	1
PIN,10X42.5 (Ref # 92043)	92043-0074	1
SPRING,STEP,LH (Ref # 92145)	92145-0198	1
SPRING,STEP,RH (Ref # 92145A)	92145-0199	1
BOLT,FLANGED,12X23 (Ref # 92153)	92153-0653	1
BOLT,FLANGED,8X25 (Ref # 92153A)	92153-0838	1