

2012 Brute Force® 750 4x4i EPS PARTS DIAGRAM

Shock Absorber(s)

F2280

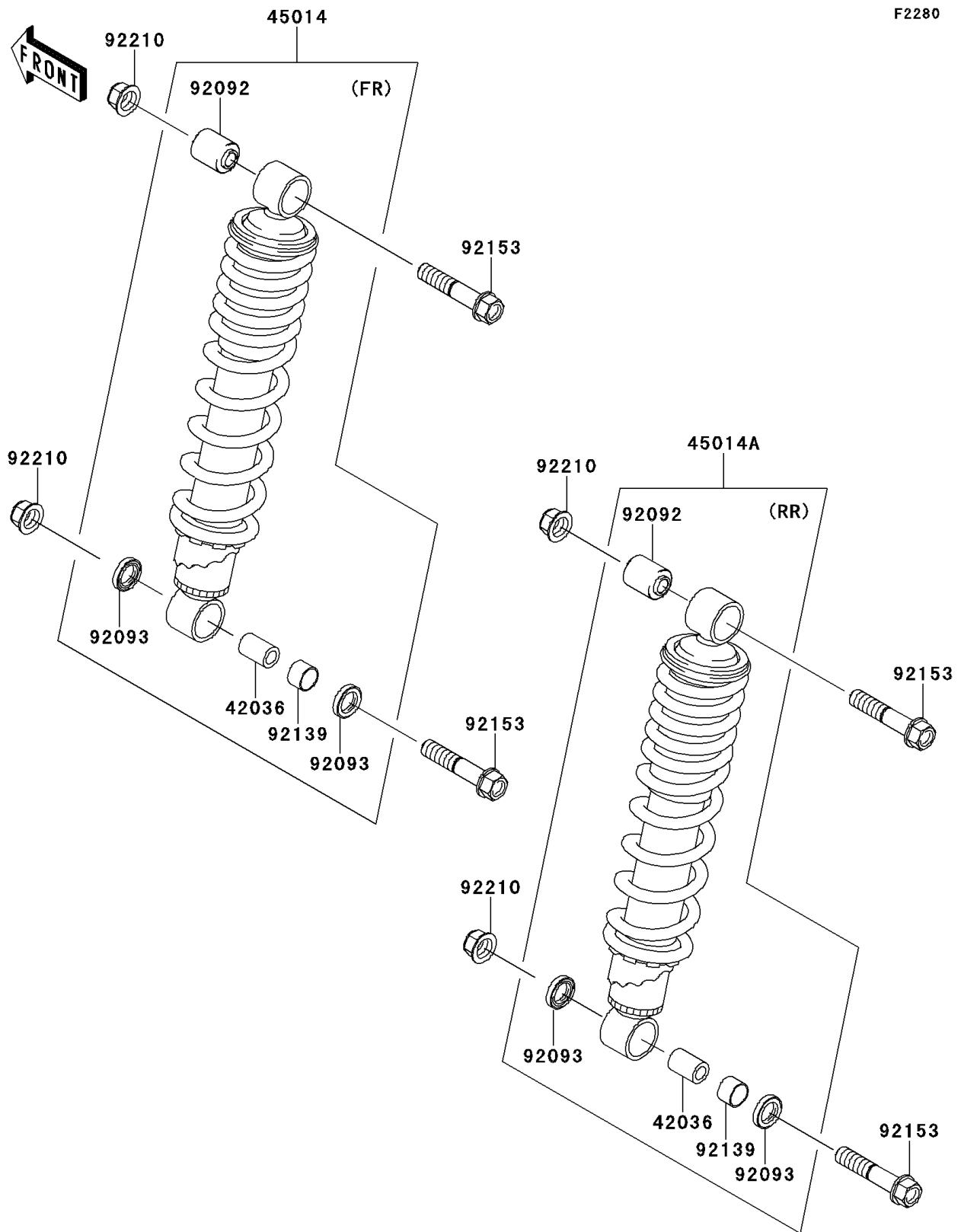

2012 Brute Force® 750 4x4i EPS PARTS LIST

Shock Absorber(s)

ITEM NAME	PART NUMBER	QUANTITY
SLEEVE (Ref # 42036)	42036-0018	1
SHOCKABSORBER,FR,BLACK (Ref # 45014)	45014-0314-17D	1
SHOCKABSORBER,RR,BLACK (Ref # 45014A)	45014-0315-17D	1
BUSHING-RUBBER (Ref # 92092)	92092-0007	1
SEAL (Ref # 92093)	92093-0033	1
BUSHING (Ref # 92139)	92139-0084	1
BOLT,FLANGED,10X50 (Ref # 92153)	92153-1139	1
NUT,LOCK,FLANGED,10MM (Ref # 92210)	92210-0276	1