

2010 Teryx® 750 FI 4x4 LE PARTS DIAGRAM

Crankcase

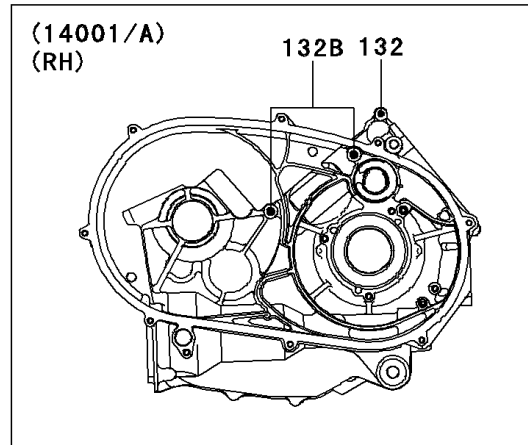
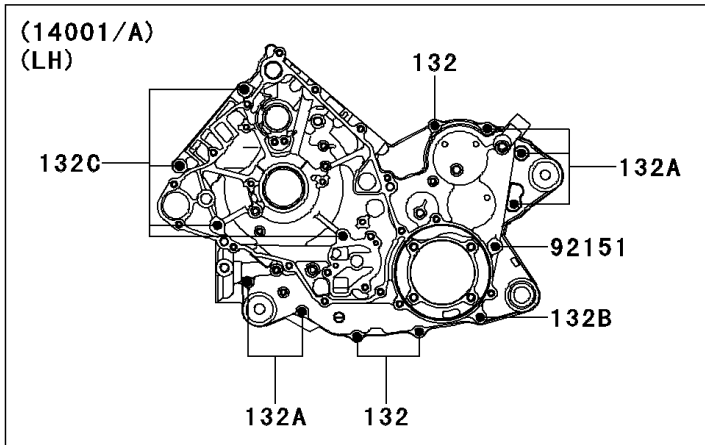
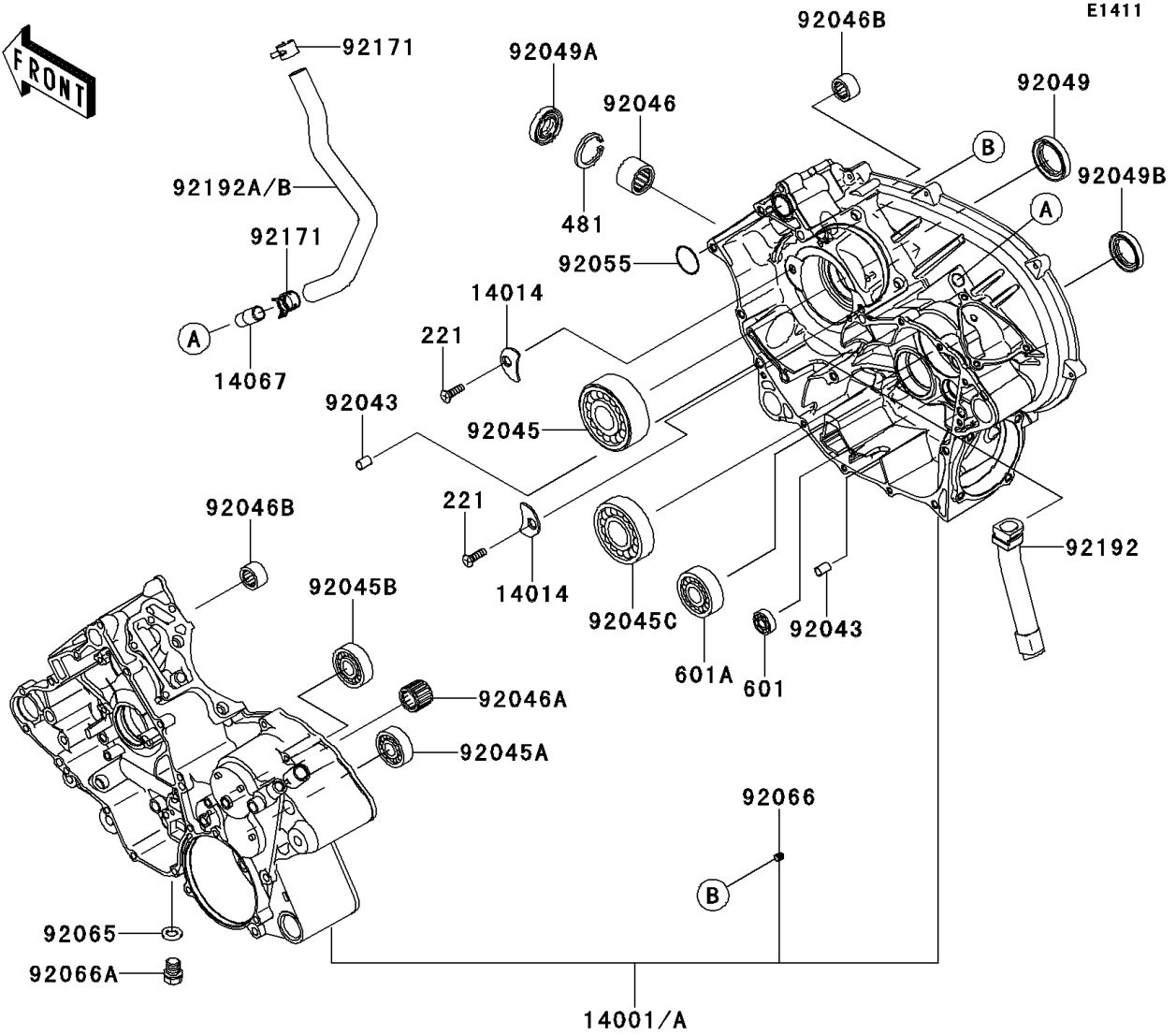

2010 Teryx® 750 FI 4x4 LE PARTS LIST

Crankcase

| ITEM NAME | PART NUMBER | QUANTITY |
|---|-------------|----------|
| BOLT-FLANGED-SMALL,6X40 (Ref # 132) | 132BD0640 | 1 |
| BOLT-FLANGED-SMALL,6X65 (Ref # 132A) | 132BD0665 | 1 |
| BOLT-FLANGED-SMALL,8X110 (Ref # 132B) | 132BD08110 | 1 |
| BOLT-FLANGED-SMALL,8X75 (Ref # 132C) | 132BD0875 | 1 |
| SCREW-CSK-CROS,6X16 (Ref # 221) | 221AA0616 | 1 |
| CIRCLIP-TYPE-C,37MM (Ref # 481) | 481J3700 | 1 |
| BEARING-BALL (Ref # 601) | 601A6000 | 1 |
| BEARING-BALL,#6304 (Ref # 601A) | 601A6304 | 1 |
| SET-CRANKCASE (Ref # 14001) | 14001-0170 | 1 |
| PLATE-POSITION (Ref # 14014) | 14014-0006 | 1 |
| FITTING,BREATHER (Ref # 14067) | 14067-006 | 1 |
| PIN,10X14 (Ref # 92043) | 92043-1506 | 1 |
| BEARING-BALL,5208X2-A-ECG45 (Ref # 92045) | 92045-0012 | 1 |
| BEARING-BALL,#6004 (Ref # 92045A) | 92045-0076 | 1 |
| BEARING-BALL,6303LUA (Ref # 92045B) | 92045-0091 | 1 |
| BEARING-BALL,6306SH2 (Ref # 92045C) | 92045-1190 | 1 |
| BEARING-NEEDLE (Ref # 92046) | 92046-0022 | 1 |
| BEARING-NEEDLE (Ref # 92046A) | 92046-0039 | 1 |
| BEARING-NEEDLE,TA202715ZE (Ref # 92046B) | 92046-1118 | 1 |
| SEAL-OIL,TC 35X50X8 (Ref # 92049) | 92049-1452 | 1 |
| SEAL-OIL,TCY 28X42X8 (Ref # 92049A) | 92049-1570 | 1 |
| SEAL-OIL,HTC 30X45X8 (Ref # 92049B) | 92049-1575 | 1 |
| RING-O,25.7X2.4 (Ref # 92055) | 92055-1136 | 1 |
| GASKET,12X22X2 (Ref # 92065) | 92065-097 | 1 |
| PLUG,OIL LINE,7.2X8 (Ref # 92066) | 92066-1012 | 1 |
| PLUG,OIL DRAIN,12X15 (Ref # 92066A) | 92066-1174 | 1 |
| BOLT,8X110 (Ref # 92151) | 92151-1689 | 1 |
| CLAMP (Ref # 92171) | 92171-0329 | 1 |
| TUBE,OIL RETURN (Ref # 92192) | 92192-0703 | 1 |

2010 Teryx® 750 FI 4x4 LE PARTS LIST

Crankcase

| ITEM NAME | PART NUMBER | QUANTITY |
|------------------------------|-------------|----------|
| TUBE,BREATHER (Ref # 92192A) | 92192-0764 | 1 |