

2010 KX™450F PARTS DIAGRAM

Rear Brake

F2294

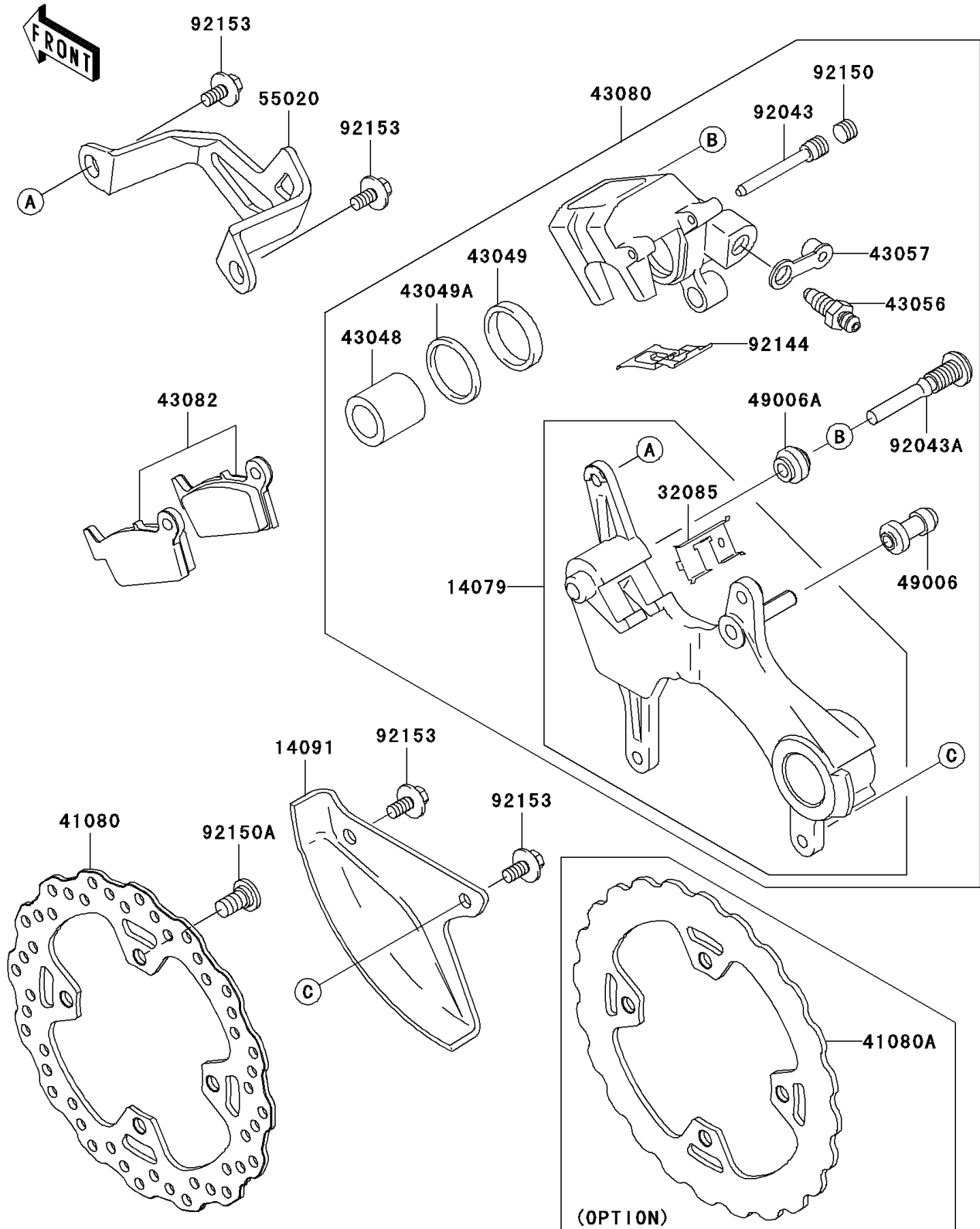

2010 KX™450F PARTS LIST

Rear Brake

ITEM NAME	PART NUMBER	QUANTITY
HOLDER-ASSY,REAR CALIPER (Ref # 14079)	14079-0022	1
COVER,REAR DISC,EBONY (Ref # 14091)	14091-1523-6C	1
STOPPER,PAD (Ref # 32085)	32085-1386	1
DISC,RR (Ref # 41080)	41080-0076	1
DISC,RR (Ref # 41080A)	41080-0094	1
PISTON-CALIPER (Ref # 43048)	43048-1066	1
PACKING (Ref # 43049)	43049-1063	1
PACKING (Ref # 43049A)	43049-1064	1
BREATHER (Ref # 43056)	43056-1055	1
CAP-BREATHER (Ref # 43057)	43057-1001	1
CALIPER-SUB-ASSY,RR (Ref # 43080)	43080-0037	1
PAD-ASSY-BRAKE (Ref # 43082)	43082-0048	1
BOOT,CALIPER (Ref # 49006)	49006-1088	1
BOOT,CALIPER (Ref # 49006A)	49006-1242	1
GUARD,REAR CALIPER,EBONY (Ref # 55020)	55020-0458-6C	1
PIN,HANGER (Ref # 92043)	92043-1507	1
PIN (Ref # 92043A)	92043-1508	1
SPRING,PAD (Ref # 92144)	92144-1819	1
BOLT,PLUG (Ref # 92150)	92150-1692	1
BOLT,DISC PLATE,8X15 (Ref # 92150A)	92150-1811	1
BOLT,FLANGED,6X14 (Ref # 92153)	92153-0936	1