

2010 KX™450F PARTS DIAGRAM

Rear Suspension

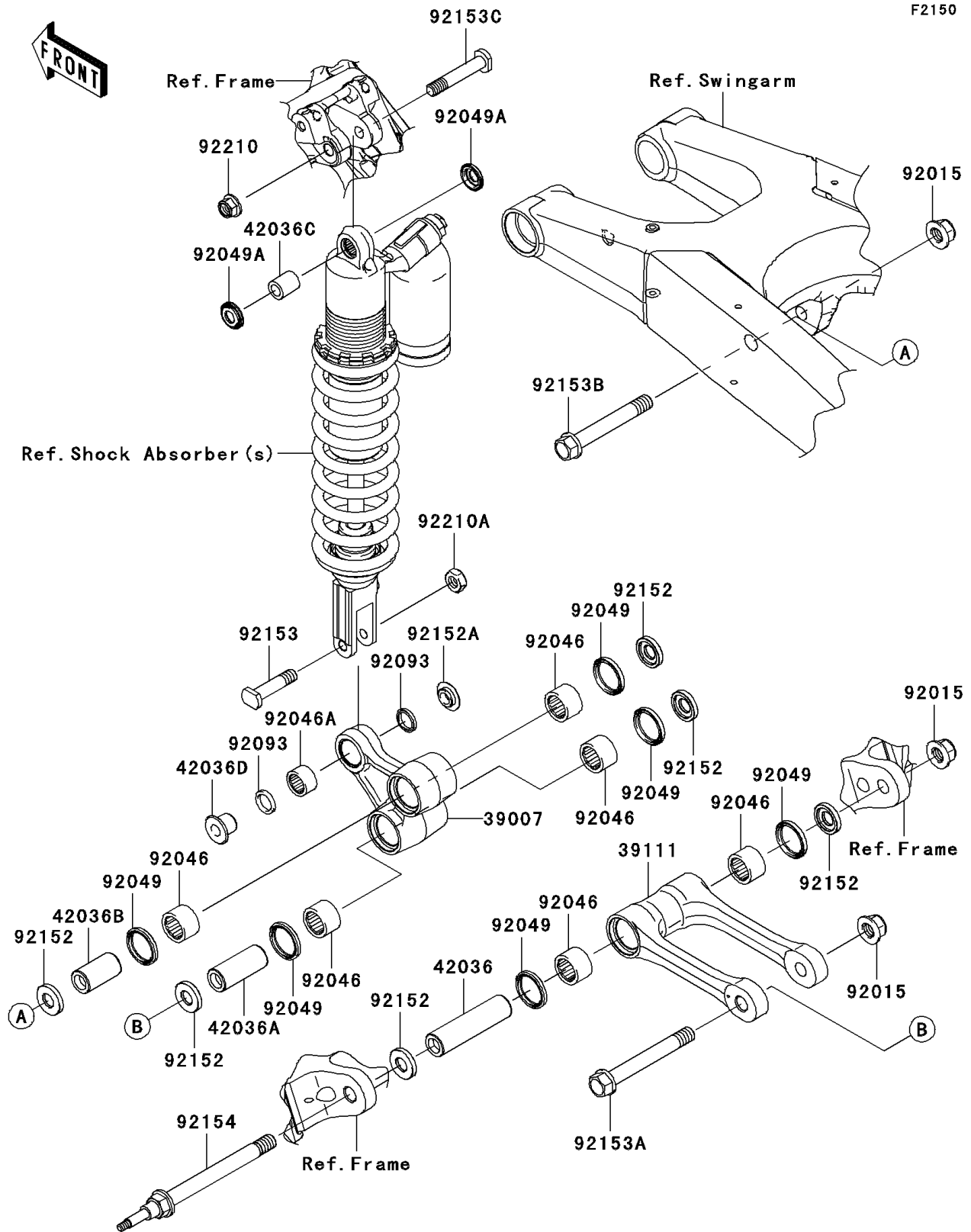

2010 KX™450F PARTS LIST

Rear Suspension

ITEM NAME	PART NUMBER	QUANTITY
ARM-SUSP,UNI TRAK (Ref # 39007)	39007-0157	1
ROD-TIE,SUSPENSION (Ref # 39111)	39111-0073	1
SLEEVE,ROD,L=78.4 (Ref # 42036)	42036-0020	1
SLEEVE,SUSPENSION ARM,L=49 (Ref # 42036A)	42036-0021	1
SLEEVE,SUSPENSION ARM,L=37 (Ref # 42036B)	42036-0022	1
SLEEVE,10X16X19.3 (Ref # 42036C)	42036-0030	1
SLEEVE (Ref # 42036D)	42036-1351	1
NUT,LOCK,FLANGED,12MM (Ref # 92015)	92015-1433	1
BEARING-NEEDLE,F-2016 (Ref # 92046)	92046-1151	1
BEARING-NEEDLE,7E-HVS16X22X12 (Ref # 92046A)	92046-1301	1
SEAL-OIL,SD026X32X4 (Ref # 92049)	92049-0063	1
SEAL-OIL (Ref # 92049A)	92049-0069	1
SEAL (Ref # 92093)	92093-1436	1
COLLAR (Ref # 92152)	92152-0425	1
COLLAR (Ref # 92152A)	92152-1139	1
BOLT,10X45 (Ref # 92153)	92153-0937	1
BOLT,FLANGED,12X95 (Ref # 92153A)	92153-0938	1
BOLT,FLANGED,12X86 (Ref # 92153B)	92153-0939	1
BOLT,10X58 (Ref # 92153C)	92153-1386	1
BOLT,12MM,L=122 (Ref # 92154)	92154-0106	1
NUT,LOCK,FLANGED,10MM (Ref # 92210)	92210-1080	1
NUT,LOCK,10MM (Ref # 92210A)	92210-1184	1