

## 2010 KX™450F PARTS DIAGRAM

Kickstarter Mechanism

E1340

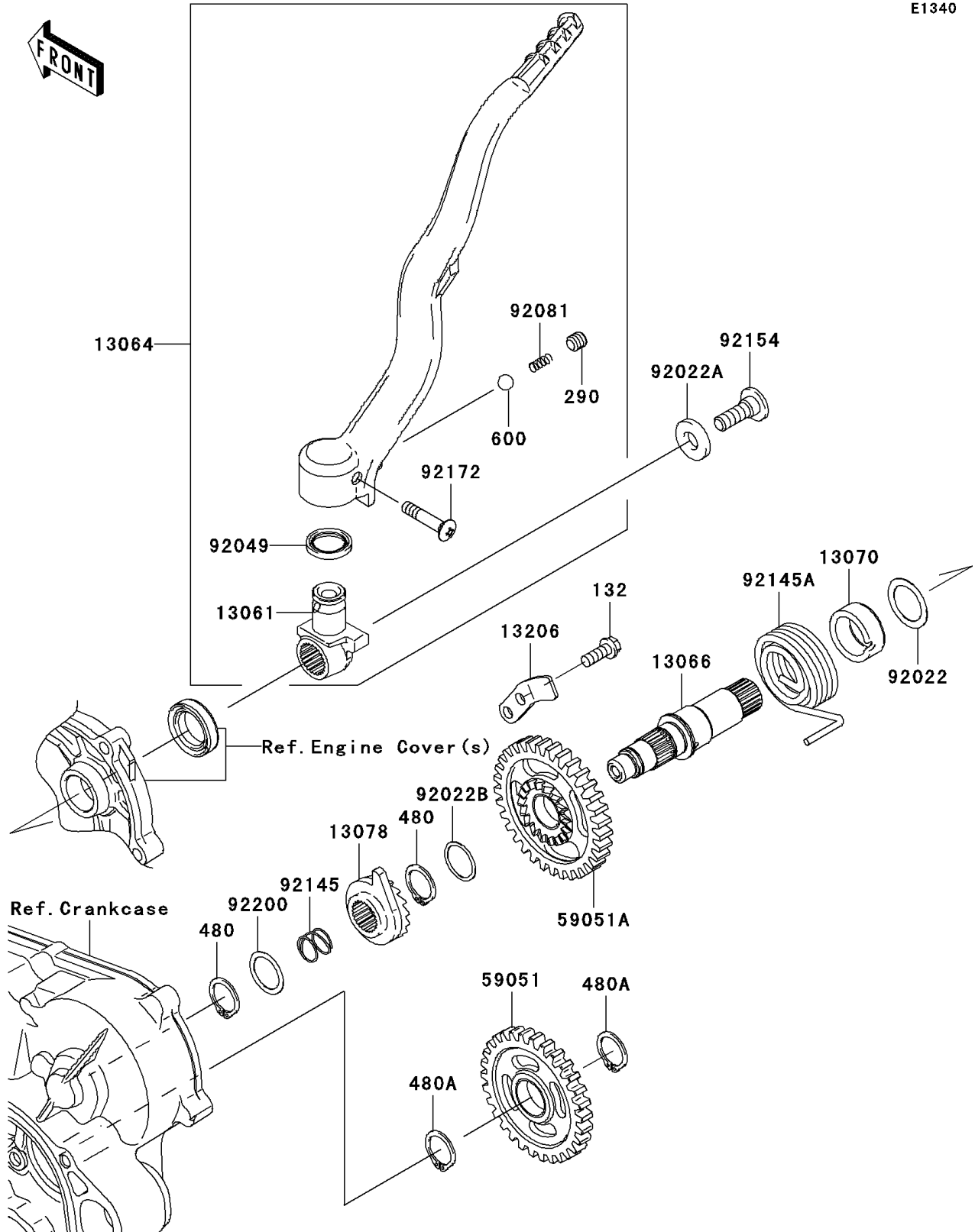

## 2010 KX™450F PARTS LIST

Kickstarter Mechanism

ITEM NAME	PART NUMBER	QUANTITY
BOLT-FLANGED-SMALL,6X16 (Ref # 132)	132BA0616	1
SCREW-SET-SOCKET,8X8 (Ref # 290)	290CA0808	1
CIRCLIP-TYPE-C,18MM (Ref # 480)	480J1800	1
CIRCLIP-TYPE-C,19MM (Ref # 480A)	480J1900	1
BALL-STEEL,1/4" (Ref # 600)	600A0800	1
BOSS (Ref # 13061)	13061-0146	1
LEVER-ASSY-KICK (Ref # 13064)	13064-0051	1
SHAFT-KICK (Ref # 13066)	13066-0010	1
GUIDE,KICK SPRING (Ref # 13070)	13070-1378	1
RATCHET (Ref # 13078)	13078-0558	1
GUIDE-KICK (Ref # 13206)	13206-0007	1
GEAR-SPUR,30T (Ref # 59051)	59051-0030	1
GEAR-SPUR,33T (Ref # 59051A)	59051-0046	1
WASHER,20.3X28.0X0.5 (Ref # 92022)	92022-1885	1
WASHER,10X22X3.2 (Ref # 92022A)	92022-1944	1
WASHER,18.3X22X0.5 (Ref # 92022B)	92022-271	1
SEAL-OIL,KICK PEDAL (Ref # 92049)	92049-1387	1
SPRING,KICK PEDAL (Ref # 92081)	92081-020	1
SPRING (Ref # 92145)	92145-0162	1
SPRING,RETURN (Ref # 92145A)	92145-0297	1
BOLT,SOCKET,8X25 (Ref # 92154)	92154-0181	1
SCREW,6X30 (Ref # 92172)	92172-1088	1
WASHER,18.3X24X0.5 (Ref # 92200)	92200-0075	1