

2010 KX™450F PARTS DIAGRAM

Camshaft(s)/Tensioner

E1230

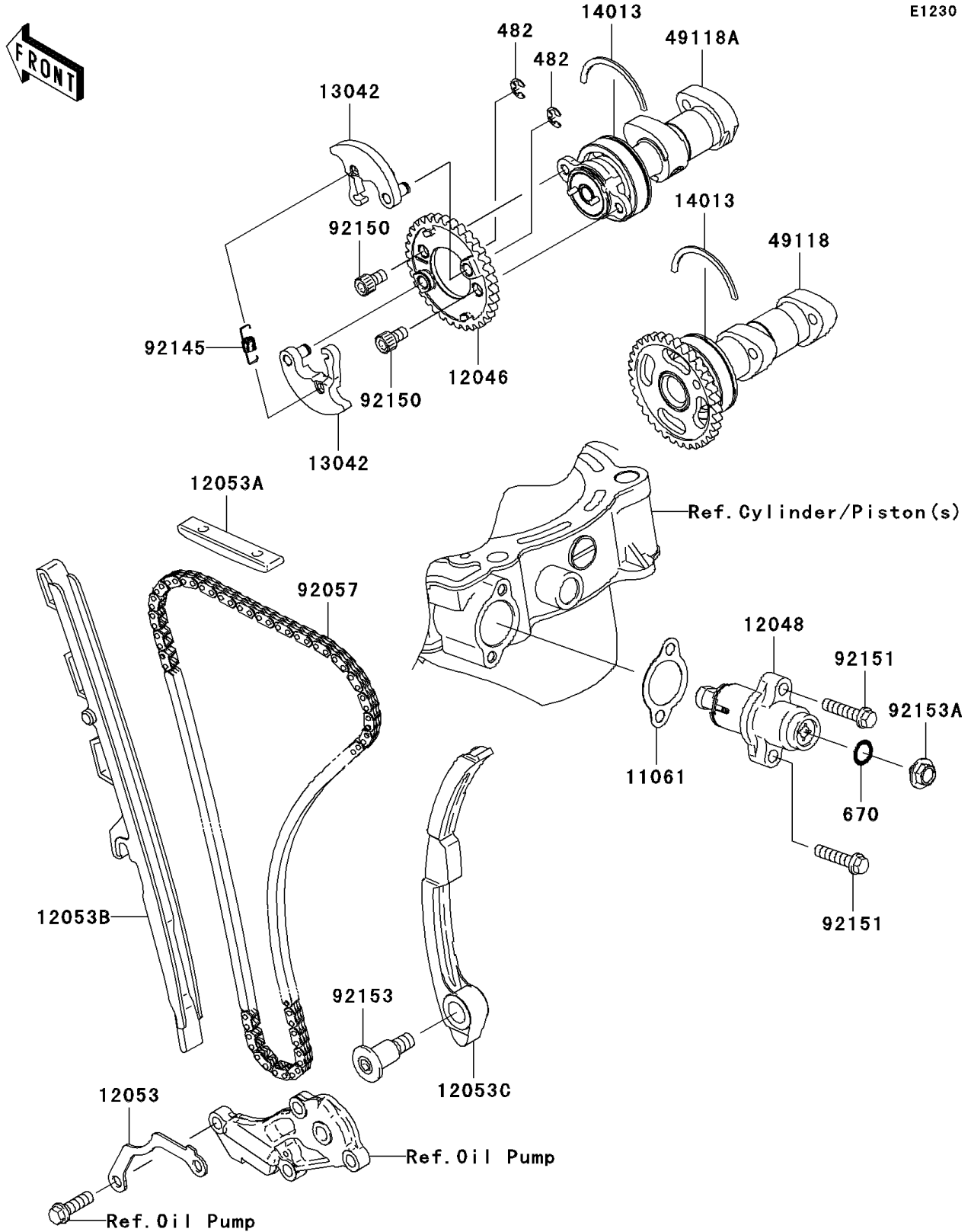

2010 KX™450F PARTS LIST

Camshaft(s)/Tensioner

ITEM NAME	PART NUMBER	QUANTITY
CIRCLIP-TYPE-E (Ref # 482)	482J5000	1
O RING (Ref # 670)	670D2010	1
GASKET (Ref # 11061)	11061-0260	1
SPROCKET,34T (Ref # 12046)	12046-0071	1
TENSIONER-ASSY (Ref # 12048)	12048-0021	1
GUIDE-CHAIN,CAM CHAIN STOPPER (Ref # 12053)	12053-0031	1
GUIDE-CHAIN,UPP (Ref # 12053A)	12053-0051	1
GUIDE-CHAIN,FR (Ref # 12053B)	12053-0135	1
GUIDE-CHAIN,RR (Ref # 12053C)	12053-0136	1
WEIGHT (Ref # 13042)	13042-0005	1
RING-POSITION (Ref # 14013)	14013-0001	1
CAMSHAFT-COMP,INTAKE (Ref # 49118)	49118-0132	1
CAMSHAFT-COMP,EXHAUST (Ref # 49118A)	49118-0133	1
CHAIN,CAM,98XRH2010-122M (Ref # 92057)	92057-0180	1
SPRING (Ref # 92145)	92145-0390	1
BOLT,SOCKET,6X10 (Ref # 92150)	92150-1650	1
BOLT,FLANGED-SMALL,6X25 (Ref # 92151)	92151-1930	1
BOLT,8X29.5 (Ref # 92153)	92153-0717	1
BOLT,6X6 (Ref # 92153A)	92153-1380	1