

2013 NINJA® ZX™-6R ABS PARTS DIAGRAM

Oil Pan

E1434

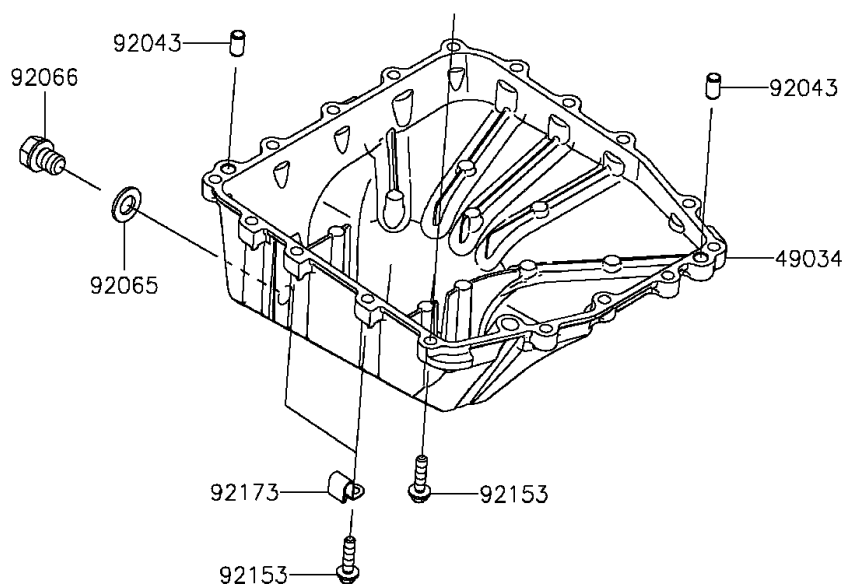
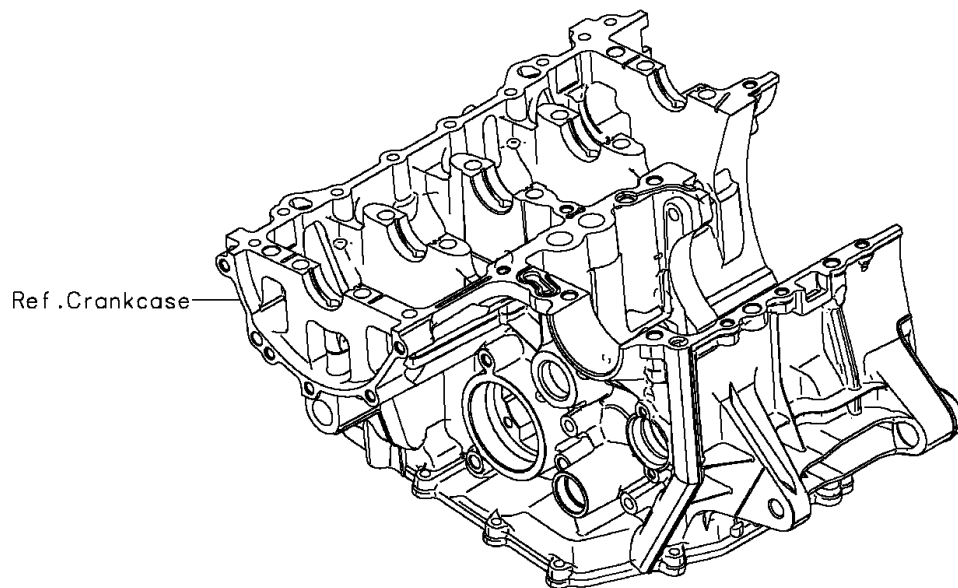

2013 NINJA® ZX™-6R ABS PARTS LIST

Oil Pan

ITEM NAME	PART NUMBER	QUANTITY
GASKET,OIL PAN (Ref # 11061)	11061-0253	1
PAN-OIL (Ref # 49034)	49034-0031	1
PIN,6.2X8X14 (Ref # 92043)	92043-1263	1
GASKET,12X22X2 (Ref # 92065)	92065-097	1
PLUG,OIL DRAIN,12X15 (Ref # 92066)	92066-1174	1
BOLT,FLANGED,6X25 (Ref # 92153)	92153-1569	1
CLAMP (Ref # 92173)	92173-0082	1