

2007 Vulcan® 900 Custom PARTS DIAGRAM

Turn Signals

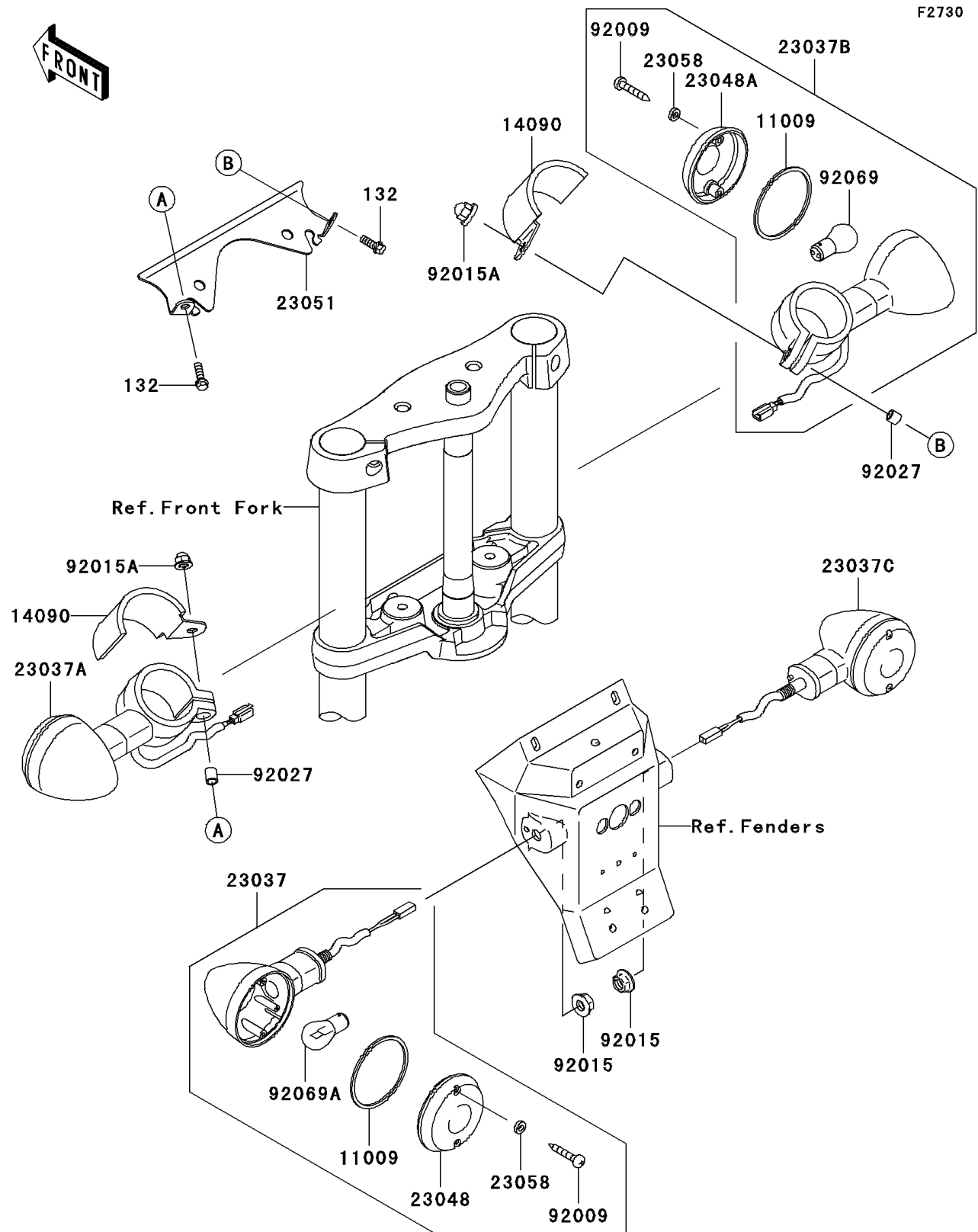

2007 Vulcan® 900 Custom PARTS LIST

Turn Signals

| ITEM NAME | PART NUMBER | QUANTITY |
|---------------------------------------|-------------|----------|
| BOLT-FLANGED-SMALL,6X20 (Ref # 132) | 132E0620 | 1 |
| GASKET,SIGNAL LAMP (Ref # 11009) | 11009-1413 | 1 |
| COVER,SIGNAL LAMP (Ref # 14090) | 14090-1578 | 1 |
| LAMP-ASSY-SIGNAL,RR,LH (Ref # 23037) | 23037-0095 | 1 |
| LAMP-ASSY-SIGNAL,FR,LH (Ref # 23037A) | 23037-0096 | 1 |
| LAMP-ASSY-SIGNAL,FR,RH (Ref # 23037B) | 23037-0097 | 1 |
| LAMP-ASSY-SIGNAL,RR,RH (Ref # 23037C) | 23037-0104 | 1 |
| LENS-SIGNAL LAMP (Ref # 23048) | 23048-1065 | 1 |
| LENS-SIGNAL LAMP (Ref # 23048A) | 23048-1066 | 1 |
| BRACKET-SIGNAL LAMP (Ref # 23051) | 23051-0019 | 1 |
| WASHER,PLAIN,4MM (Ref # 23058) | 23058-002 | 1 |
| SCREW,TAPPING,4X25 (Ref # 92009) | 92009-1637 | 1 |
| NUT,10MM (Ref # 92015) | 92015-1356 | 1 |
| NUT,CAP,6MM (Ref # 92015A) | 92015-1385 | 1 |
| COLLAR,6.8X10X12 (Ref # 92027) | 92027-162 | 1 |
| BULB,12V 21/5W (Ref # 92069) | 92069-063 | 1 |
| BULB,12V 21W (Ref # 92069A) | | 1 |