

2009 Vulcan® 1700 Nomad™ PARTS DIAGRAM

Crankcase Bolt Pattern

E1412

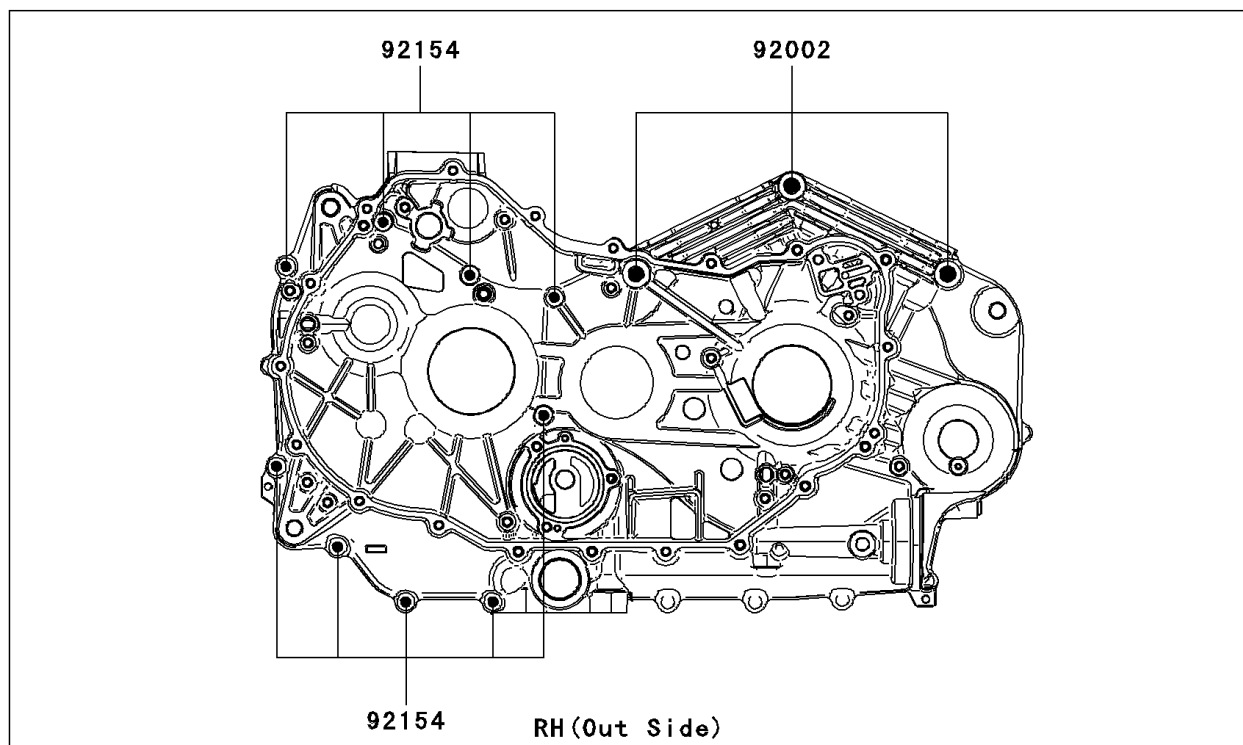
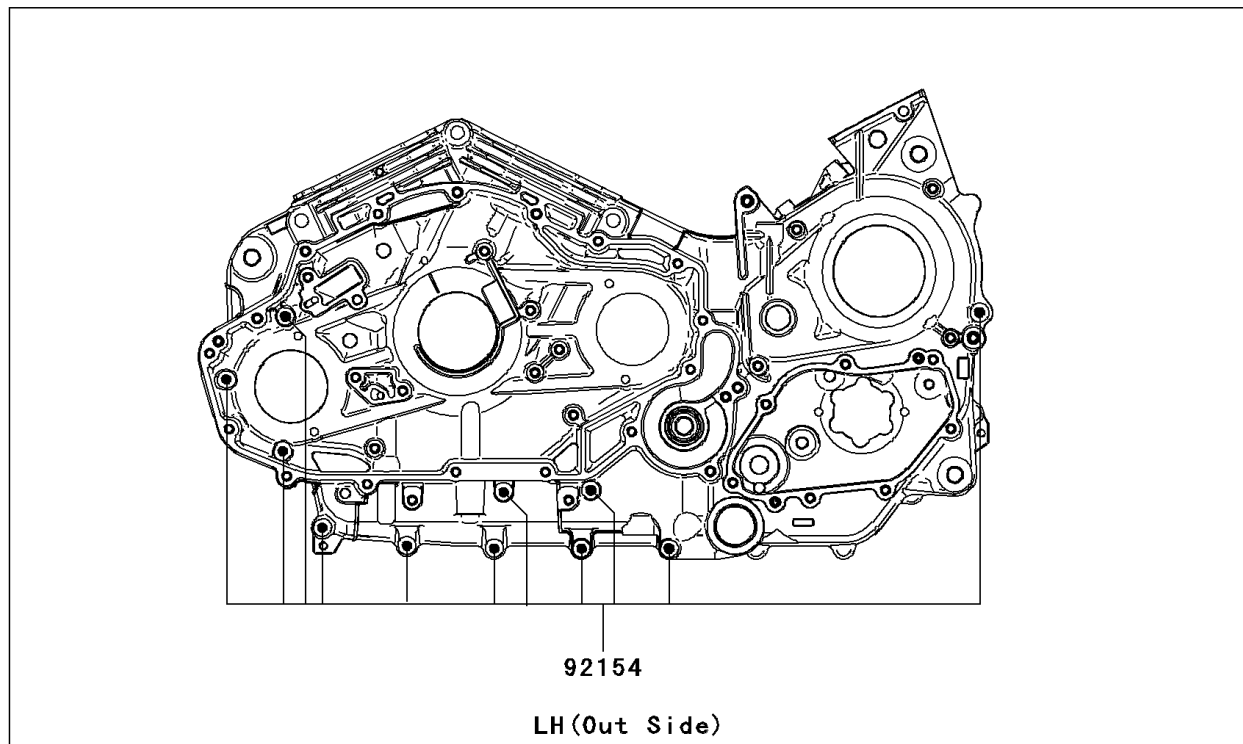

2009 Vulcan® 1700 Nomad™ PARTS LIST

Crankcase Bolt Pattern

ITEM NAME	PART NUMBER	QUANTITY
BOLT,FLANGED,10X190 (Ref # 92002)	92002-1548	1
BOLT,FLANGED-SMALL,6X90 (Ref # 92154)	92154-0132	1