

2006 Vulcan® 900 Classic LT PARTS DIAGRAM

Crankcase Bolt Pattern

E1412

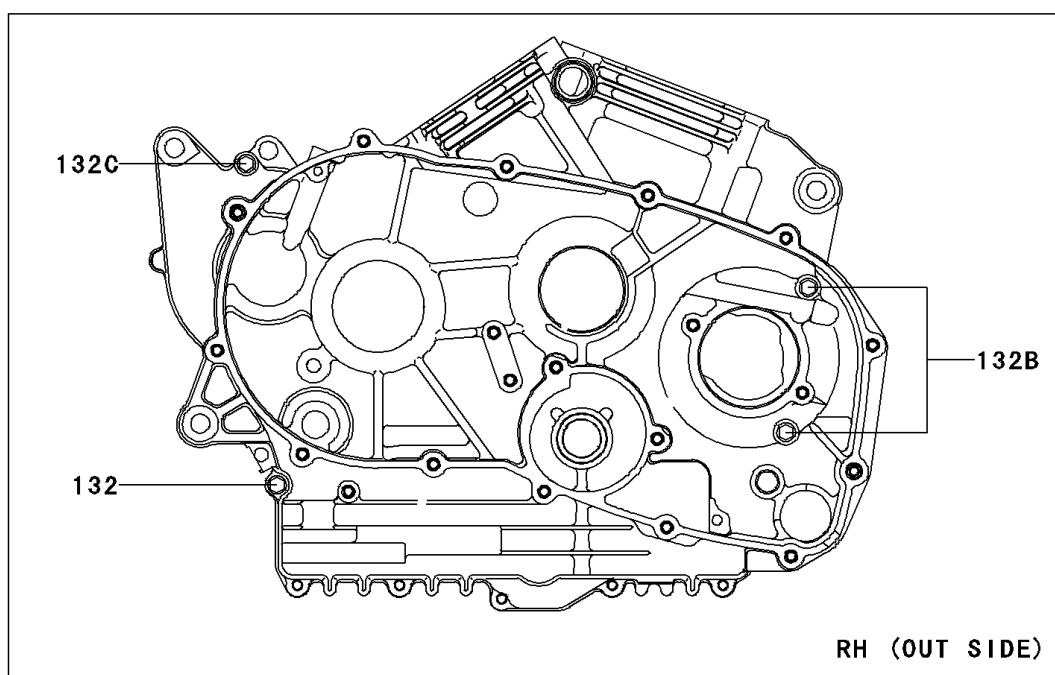
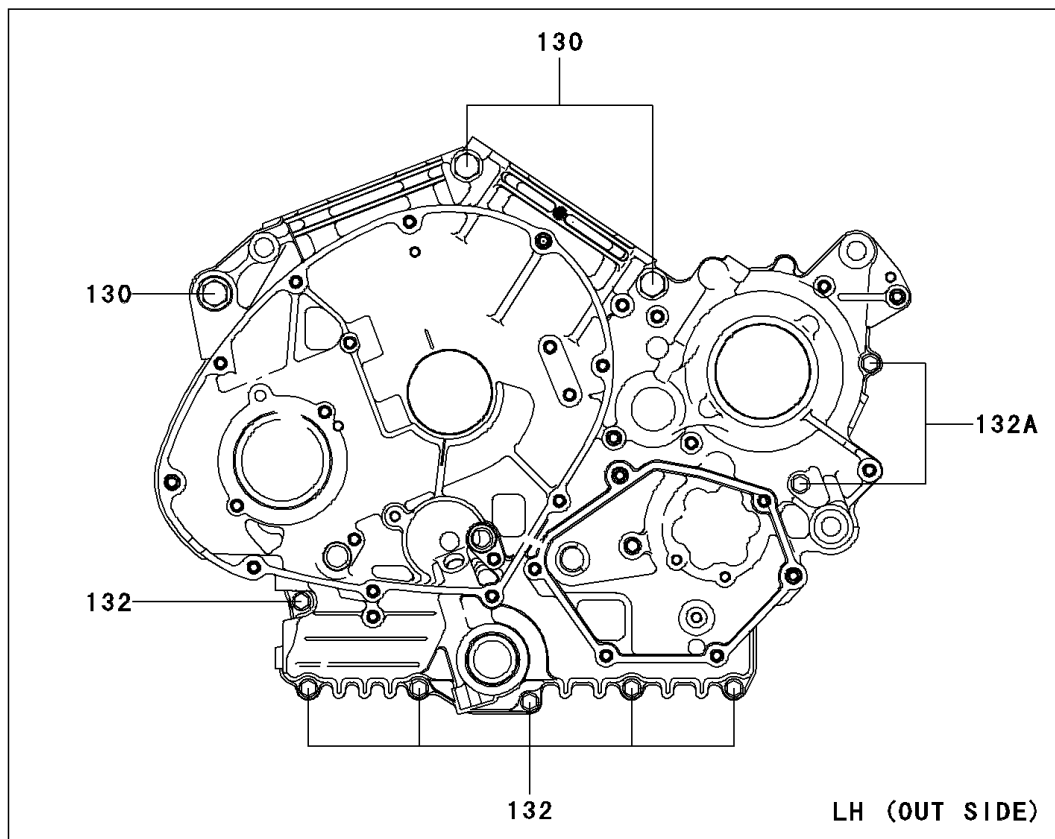

2006 Vulcan® 900 Classic LT PARTS LIST

Crankcase Bolt Pattern

ITEM NAME	PART NUMBER	QUANTITY
BOLT-FLANGED,10X90 (Ref # 130)	130BB1090	1
BOLT-FLANGED-SMALL,6X30 (Ref # 132)	132BB0630	1
BOLT-FLANGED-SMALL,6X60 (Ref # 132A)	132BB0660	1
BOLT-FLANGED-SMALL,6X70 (Ref # 132B)	132BB0670	1
BOLT-FLANGED-SMALL,6X85 (Ref # 132C)	132BB0685	1