

2013 NINJA® ZX™-14R ABS PARTS DIAGRAM

Battery Case

F2132

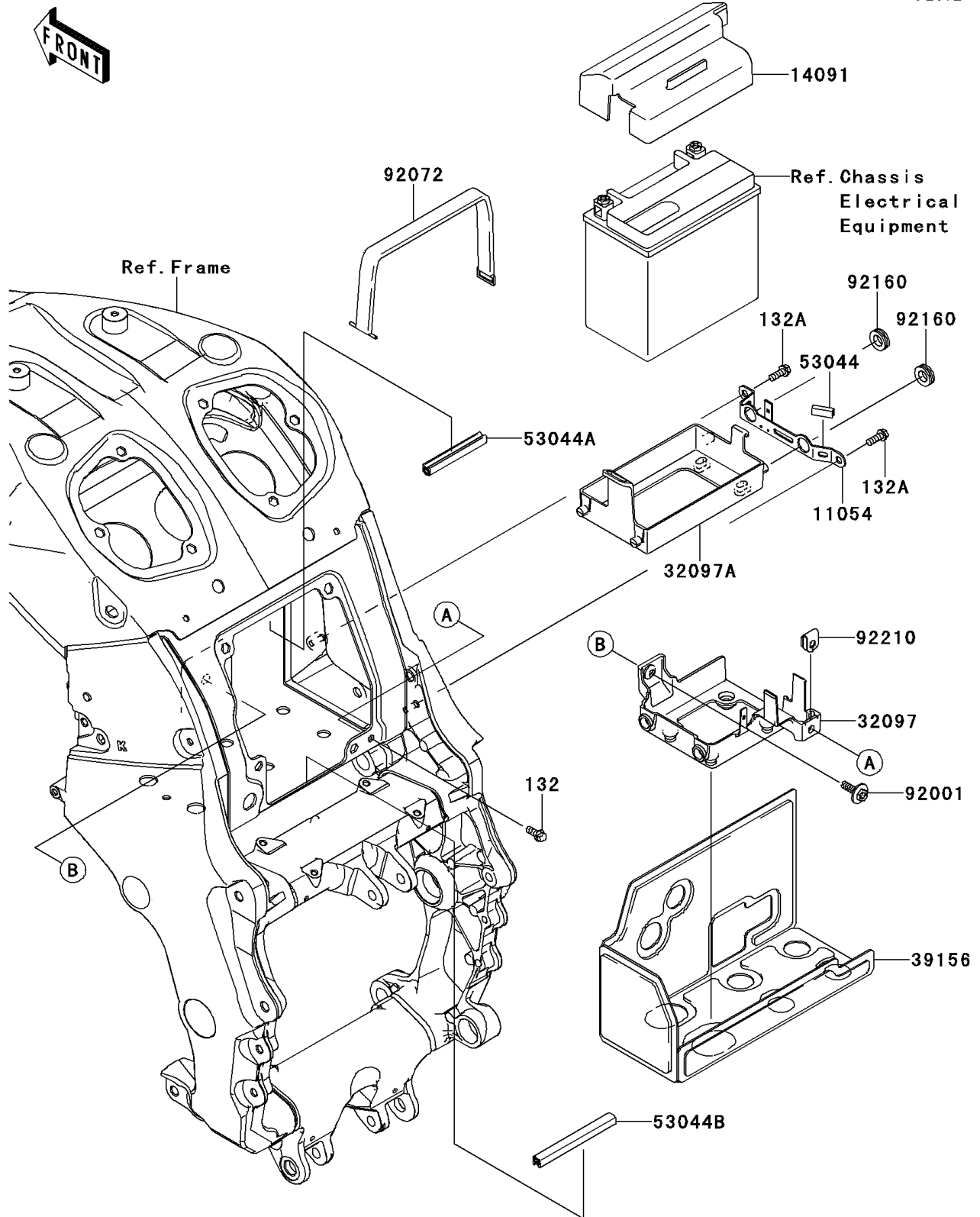

2013 NINJA® ZX™-14R ABS PARTS LIST

Battery Case

ITEM NAME	PART NUMBER	QUANTITY
BOLT-FLANGED-SMALL,6X14 (Ref # 132)	132BA0614	1
BOLT-FLANGED-SMALL,6X16 (Ref # 132A)	132BA0616	1
BRACKET,BATTERY (Ref # 11054)	11054-0633	1
COVER,BATTERY,UPP (Ref # 14091)	14091-0533	1
CASE-BATTERY (Ref # 32097)	32097-0012	1
CASE-BATTERY (Ref # 32097A)	32097-0013	1
PAD,BATTERY BOX (Ref # 39156)	39156-0602	1
TRIM,L=20 (Ref # 53044)	53044-0021	1
TRIM (Ref # 53044A)	53044-0560	1
TRIM,L=100 (Ref # 53044B)	53044-1200	1
BOLT,UPSET-WP,6X22 (Ref # 92001)	92001-1774	1
BAND,L=290 (Ref # 92072)	92072-1377	1
DAMPER (Ref # 92160)	92160-1278	1
NUT,6MM (Ref # 92210)	92210-0277	1