

2002 NINJA® ZX™-9R PARTS DIAGRAM

Engine Cover(s)

E1431

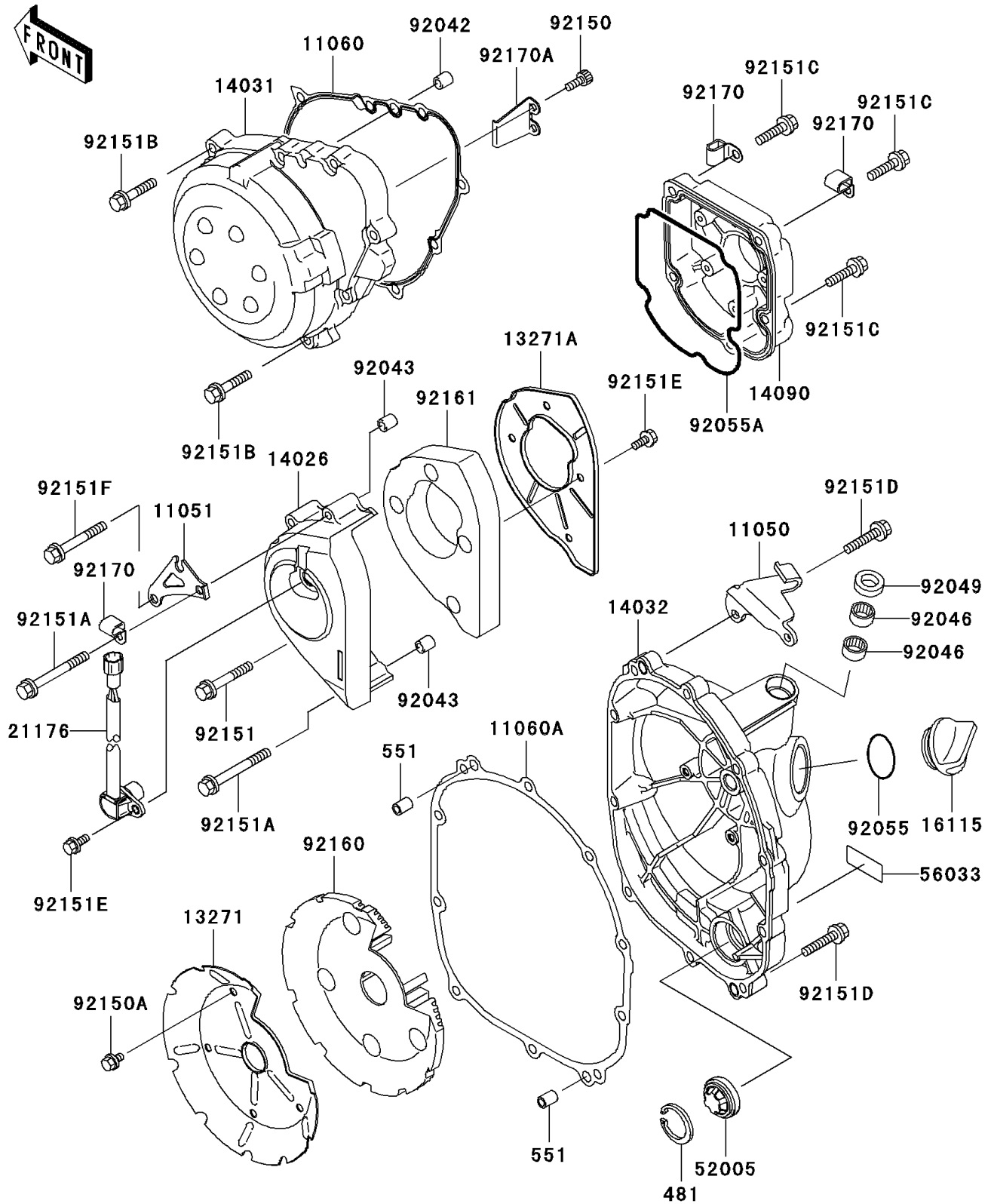

2002 NINJA® ZX™-9R PARTS LIST

Engine Cover(s)

ITEM NAME	PART NUMBER	QUANTITY
CIRCLIP-TYPE-C,30MM (Ref # 481)	481J3000	1
PIN-DOWEL,8X14 (Ref # 551)	551A0814	1
BRACKET,CLUTCH CABLE (Ref # 11050)	11050-1435	1
BRACKET,CABLE (Ref # 11051)	11051-1807	1
GASKET,GENERATOR COVER (Ref # 11060)	11060-1854	1
GASKET,CLUTCH COVER (Ref # 11060A)	11060-1855	1
PLATE (Ref # 13271)	13271-1053	1
PLATE (Ref # 13271A)	13271-1055	1
COVER-CHAIN (Ref # 14026)	14026-1272	1
COVER-GENERATOR (Ref # 14031)	14031-1371	1
COVER-CLUTCH (Ref # 14032)	14032-1528	1
COVER,PULSE (Ref # 14090)	14090-1859	1
CAP-OIL FILLER (Ref # 16115)	16115-1009	1
SENSOR,SPEED (Ref # 21176)	21176-1076	1
GAUGE (Ref # 52005)	52005-1120	1
LABEL-MANUAL,OIL CAPACITY (Ref # 56033)	56033-1075	1
PIN,DOWEL,6.3X8X14 (Ref # 92042)	92042-007	1
PIN,8X16 (Ref # 92043)	92043-1322	1
BEARING-NEEDLE,HK1210 (Ref # 92046)	92046-1010	1
SEAL-OIL,CLUTCH RELEASE (Ref # 92049)	92049-1475	1
RING-O,31.7X2.4 (Ref # 92055)	92055-049	1
RING-O,PULSE COVER (Ref # 92055A)	92055-1570	1
BOLT,SOCKET,5X14 (Ref # 92150)	92150-1180	1
BOLT,5X8 (Ref # 92150A)	92150-1406	1
BOLT,6X40 (Ref # 92151)	92151-1131	1
BOLT,6X55 (Ref # 92151A)	92151-1132	1
BOLT,6X30 (Ref # 92151B)	92151-1134	1
BOLT,6X25 (Ref # 92151C)	92151-1225	1
BOLT,6X30 (Ref # 92151D)	92151-1228	1

2002 NINJA® ZX™-9R PARTS LIST

Engine Cover(s)

ITEM NAME	PART NUMBER	QUANTITY
BOLT,5X12 (Ref # 92151E)	92151-1249	1
BOLT,6X45 (Ref # 92151F)	92151-1336	1
DAMPER (Ref # 92160)	92160-1920	1
DAMPER (Ref # 92161)	92161-1148	1
CLAMP (Ref # 92170)	92170-1577	1
CLAMP (Ref # 92170A)	92170-1579	1