

1991 NINJA® ZX™-7 PARTS DIAGRAM

Handlebar

F2310

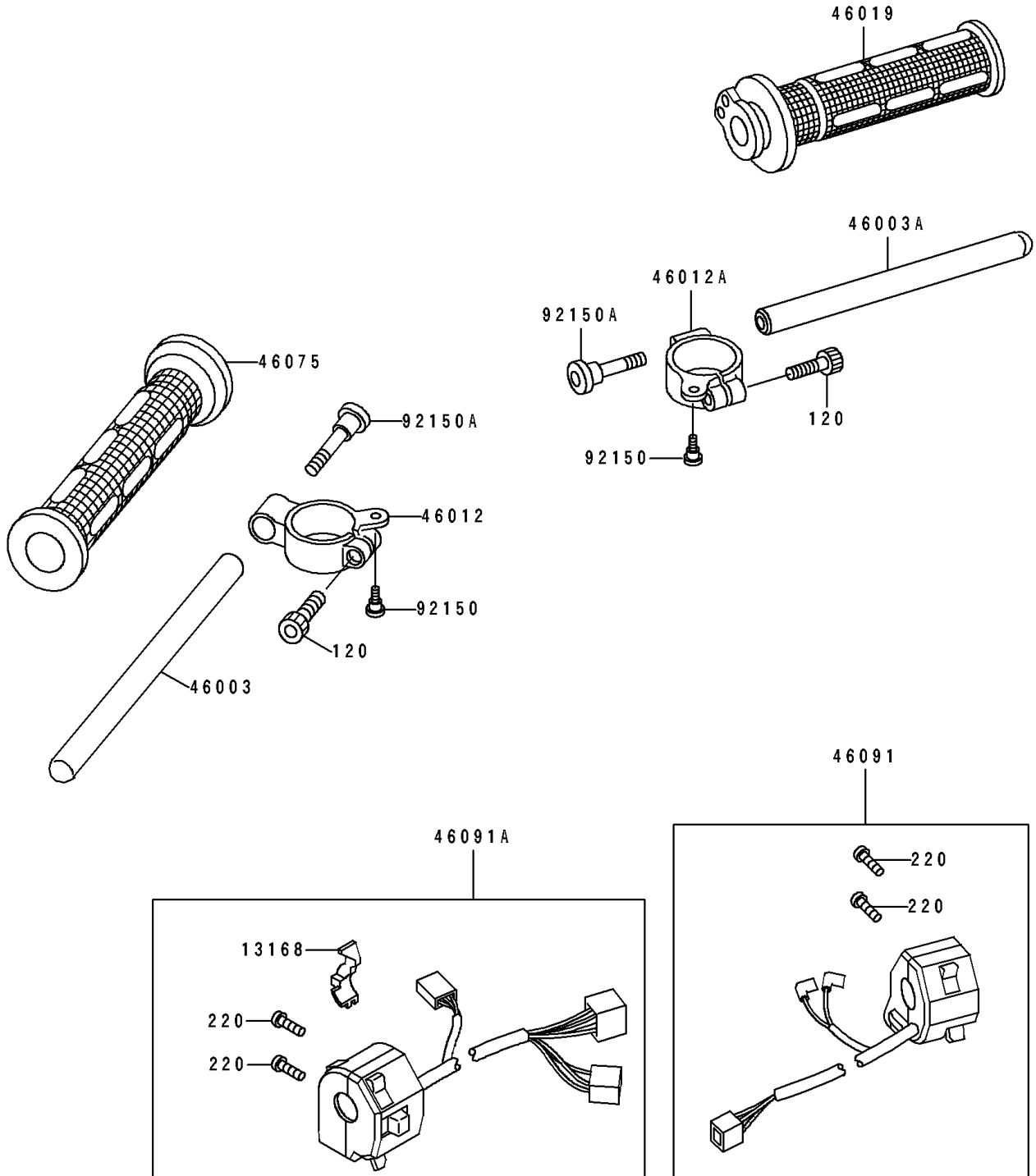

1991 NINJA® ZX™-7 PARTS LIST

Handlebar

ITEM NAME	PART NUMBER	QUANTITY
LEVER,CHOKE (Ref # 13168)	13168-1374	1
HANDLE,LH (Ref # 46003)	46003-1340	1
HANDLE,RH (Ref # 46003A)	46003-1341	1
HOLDER-HANDLE,LH (Ref # 46012)	46012-1236	1
HOLDER-HANDLE,RH (Ref # 46012A)	46012-1237	1
GRIP-ASSY,THROTTLE (Ref # 46019)	46019-1072	1
GRIP,LH (Ref # 46075)	46075-1088	1
HOUSING-ASSY-CONTROL,RH (Ref # 46091)	46091-1439	1
HOUSING-ASSY-CONTROL,LH (Ref # 46091A)	46091-1574	1
BOLT,6MM (Ref # 92150)	92150-1090	1
BOLT,SOCKET,10X37 (Ref # 92150A)	92150-1469	1
BOLT-SOCKET,8X30 (Ref # 120)	120P0830	1
SCREW-PAN-CROS (Ref # 220)	220C0520	1