

1990 NINJA® ZX™-7 PARTS DIAGRAM

Rear Wheel/Chain

F2240

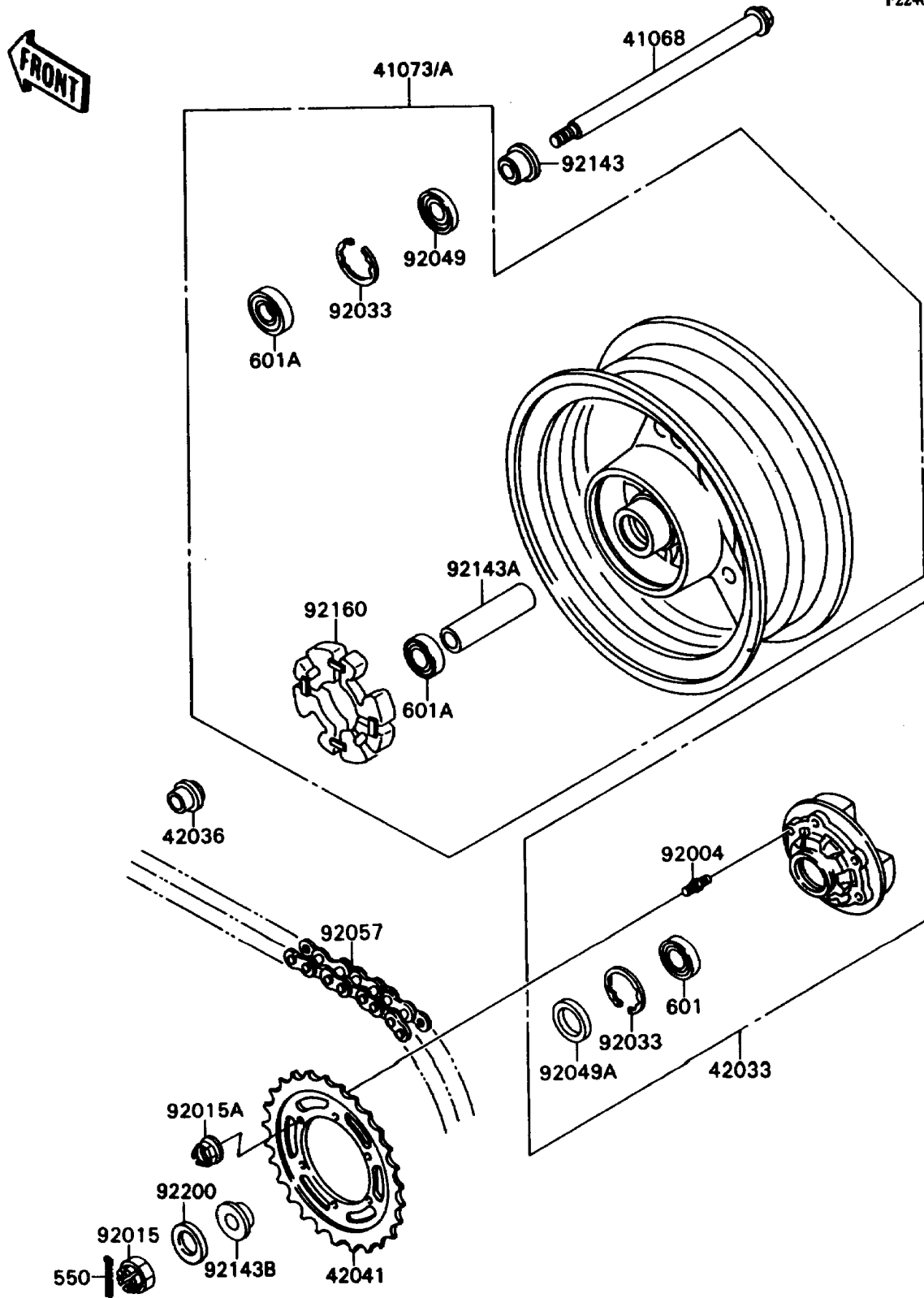

1990 NINJA® ZX™-7 PARTS LIST

Rear Wheel/Chain

ITEM NAME	PART NUMBER	QUANTITY
AXLE,RR (Ref # 41068)	41068-1315	1
WHEEL-ASSY,RR,L.GREEN (Ref # 41073)	41073-1470-CJ	1
WHEEL-ASSY,RR,P.C.GRAY (Ref # 41073A)	41073-1470-DH	1
COUPLING-ASSY,RR HUB (Ref # 42033)	42033-1139	1
SLEEVE,RR HUB,L=23 (Ref # 42036)	42036-1251	1
SPROCKET-HUB,46T (Ref # 42041)	42041-1355	1
STUD,10X19.5 (Ref # 92004)	92004-1151	1
NUT,CASTLE,18MM (Ref # 92015)	42045-018	1
NUT,10MM (Ref # 92015A)	92015-1720	1
RING-SNAP,52MM (Ref # 92033)	92033-1043	1
SEAL-OIL,28X52X5 (Ref # 92049)	92049-1061	1
SEAL-OIL,TWC35527 (Ref # 92049A)	92052-006	1
CHAIN,DRIVE,EK50MV-X (Ref # 92057)	92057-1304	1
COLLAR,L=23 (Ref # 92143)	92143-1042	1
COLLAR,RR HUB,L=133 (Ref # 92143A)	92143-1303	1
COLLAR,RR AXLE,L=18 (Ref # 92143B)	92143-1399	1
DAMPER,SHOCK,RR HUB (Ref # 92160)	92160-1203	1
WASHER,18.5X32X2.3 (Ref # 92200)	92200-1043	1
PIN-COTTER,4.0X35 (Ref # 550)	550D4035	1
BEARING-BALL,#6205G (Ref # 601)	601B6205G	1
BEARING-BALL (Ref # 601A)	601B6304UG	1