

1990 NINJA® ZX™-7 PARTS DIAGRAM

Front Wheel

F2230

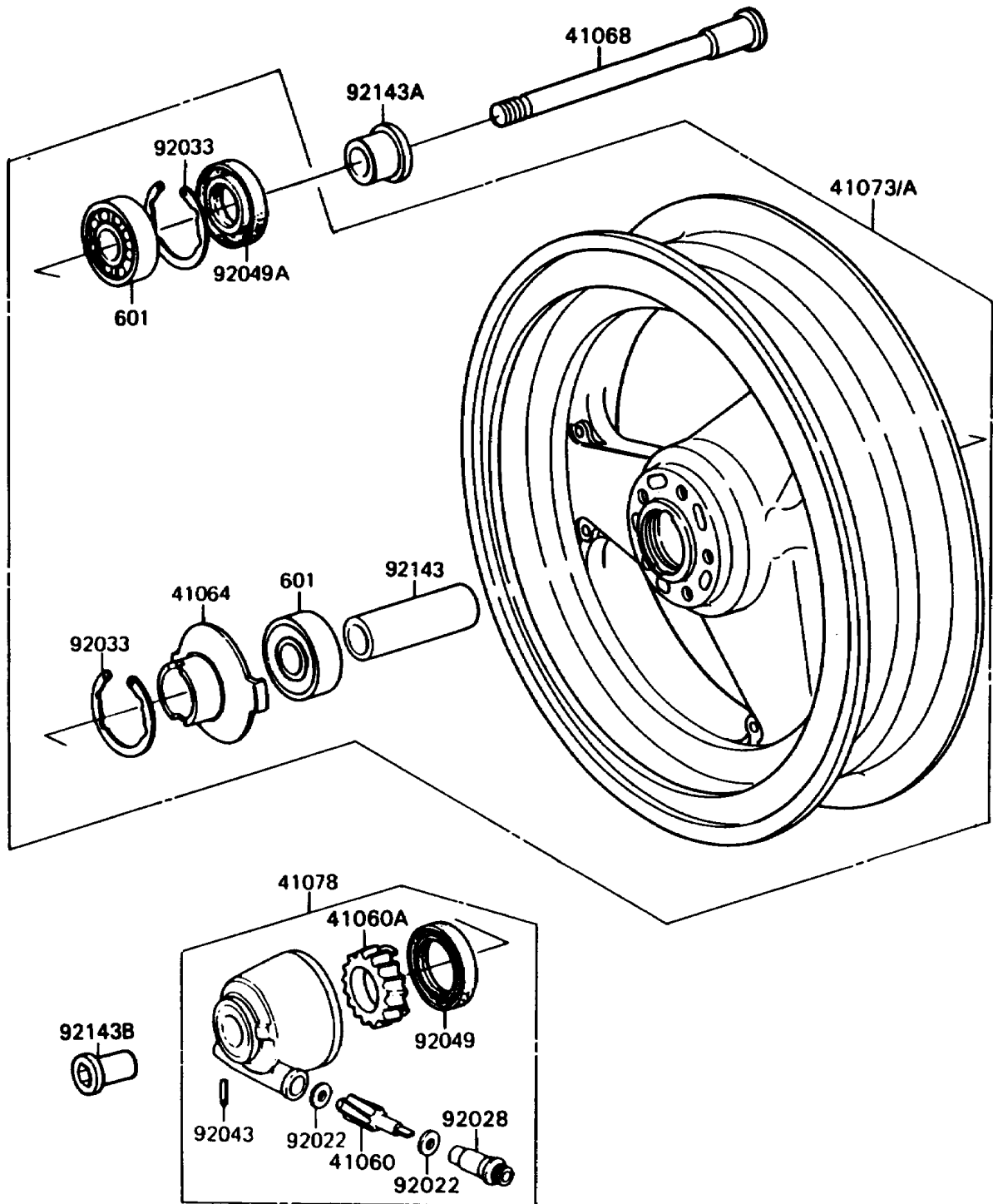

1990 NINJA® ZX™-7 PARTS LIST

Front Wheel

ITEM NAME	PART NUMBER	QUANTITY
GEAR-METER SCREW,9T (Ref # 41060)	41060-1123	1
GEAR-METER SCREW,24T (Ref # 41060A)	41060-1135	1
RECEIVER-SPEEDOMETER (Ref # 41064)	41064-1054	1
AXLE,FR (Ref # 41068)	41068-1311	1
WHEEL-ASSY,FR,L.GREEN (Ref # 41073)	41073-1414-CJ	1
WHEEL-ASSY,FR,P.C.GRAY (Ref # 41073A)	41073-1414-DH	1
CASE-ASSY-METER GEAR (Ref # 41078)	41078-1075	1
WASHER,5.1X9X0.4 (Ref # 92022)	41063-001	1
BUSHING,SPEEDOMETER (Ref # 92028)	92028-1066	1
RING-SNAP,47MM (Ref # 92033)	92033-1042	1
PIN,SPRING (Ref # 92043)	41082-001	1
SEAL-OIL,BJN30427-C3 (Ref # 92049)	92049-1057	1
SEAL-OIL (Ref # 92049A)	92049-1337	1
COLLAR,20.2X29X89 (Ref # 92143)	92143-1199	1
COLLAR,FR AXLE,L=19 (Ref # 92143A)	92143-1300	1
COLLAR,FR AXLE,L=43.5 (Ref # 92143B)	92143-1301	1
BEARING-BALL,6204UUC3 (Ref # 601)	601B6204UU	1