

1990 NINJA® ZX™-7 PARTS DIAGRAM

Gear Change Drum/Shift Fork(s)

E1362

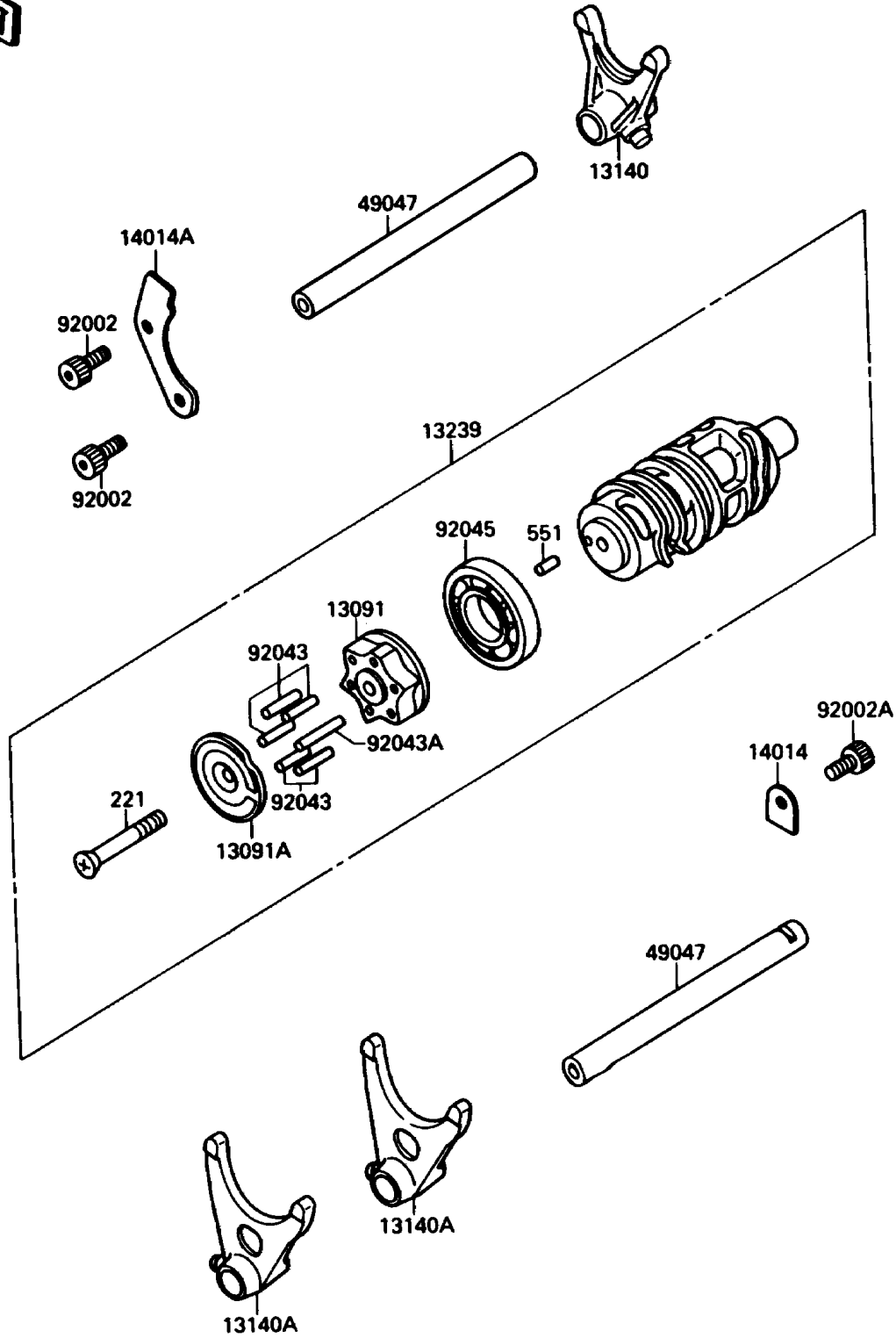

1990 NINJA® ZX™-7 PARTS LIST

Gear Change Drum/Shift Fork(s)

ITEM NAME	PART NUMBER	QUANTITY
HOLDER,CHANGE DRUM (Ref # 13091)	13091-1275	1
HOLDER,NEUTRAL (Ref # 13091A)	13091-1334	1
FORK-SHIFT,INPUT (Ref # 13140)	13140-1153	1
FORK-SHIFT,OUTPUT (Ref # 13140A)	13140-1154	1
DRUM-ASSY-CHANGE (Ref # 13239)	13239-1134	1
PLATE-POSITION,ROD (Ref # 14014)	14014-1080	1
PLATE-POSITION,DRUM (Ref # 14014A)	14014-1081	1
ROD-SHIFT (Ref # 49047)	49047-1070	1
BOLT,SOCKET,6X14 (Ref # 92002)	92002-1592	1
BOLT,SOCKET,6X12 (Ref # 92002A)	92002-1796	1
PIN,DOWEL,4X15.8 (Ref # 92043)	92042-014	1
PIN,DOWEL,4X17.8 (Ref # 92043A)	92042-020	1
BEARING-BALL,16005(NTN) (Ref # 92045)	92045-1045	1
SCREW-CSK-CROS (Ref # 221)	221B0640	1
PIN-DOWEL,4X8 (Ref # 551)	551A0408	1