

1998 NINJA® ZX™-6R PARTS DIAGRAM

Rear Brake

F2294

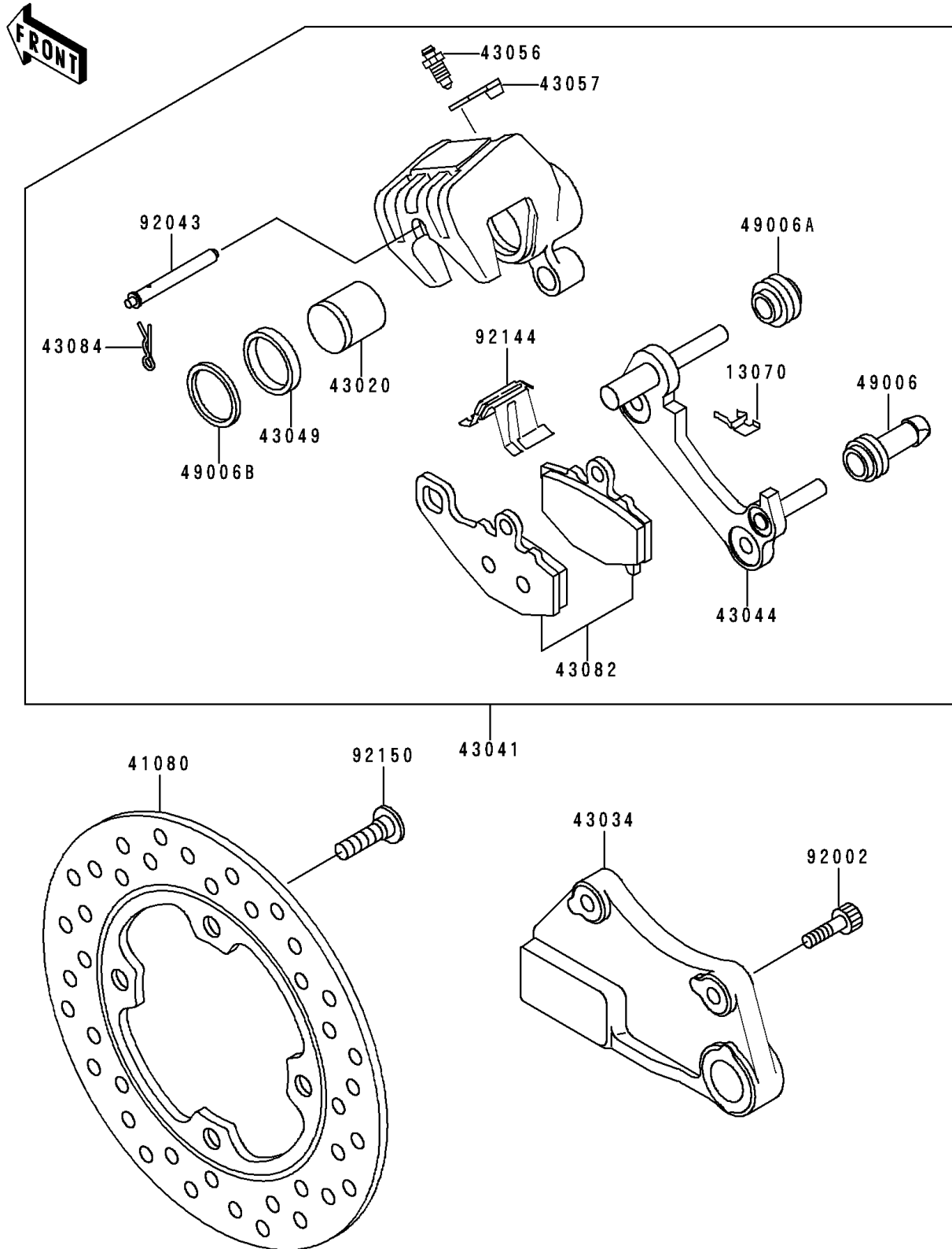

1998 NINJA® ZX™-6R PARTS LIST

Rear Brake

ITEM NAME	PART NUMBER	QUANTITY
GUIDE (Ref # 13070)	13070-1273	1
DISC,RR,GOLD (Ref # 41080)	41080-1443-CL	1
PISTON-COMP-BRAKE (Ref # 43020)	43020-1119	1
HOLDER-BRAKE,REAR CALIPER (Ref # 43034)	43034-1152	1
CALIPER-ASSY,RR (Ref # 43041)	43041-1662	1
HOLDER-COMP-CALIPER,RR (Ref # 43044)	43044-1110	1
PACKING,PISTON SEAL (Ref # 43049)	43049-001	1
BREATHER-BRAKE (Ref # 43056)	43056-1054	1
CAP-BREATHER (Ref # 43057)	43057-003	1
PAD-ASSY-BRAKE (Ref # 43082)	43082-1213	1
CLAMP,PAD (Ref # 43084)	43084-003	1
BOOT,CALIPER (Ref # 49006)	49006-1054	1
BOOT,CALIPER (Ref # 49006A)	49006-1095	1
BOOT,PISTON SEAL (Ref # 49006B)	49006-1212	1
BOLT,SOCKET,8X20 (Ref # 92002)	92002-1178	1
PIN,PAD (Ref # 92043)	92043-1489	1
SPRING,PAD (Ref # 92144)	92144-1719	1
BOLT,SOCKET,8X30 (Ref # 92150)	92150-1771	1