

1995 NINJA® ZX™-6R PARTS DIAGRAM

Chassis Electrical Equipment

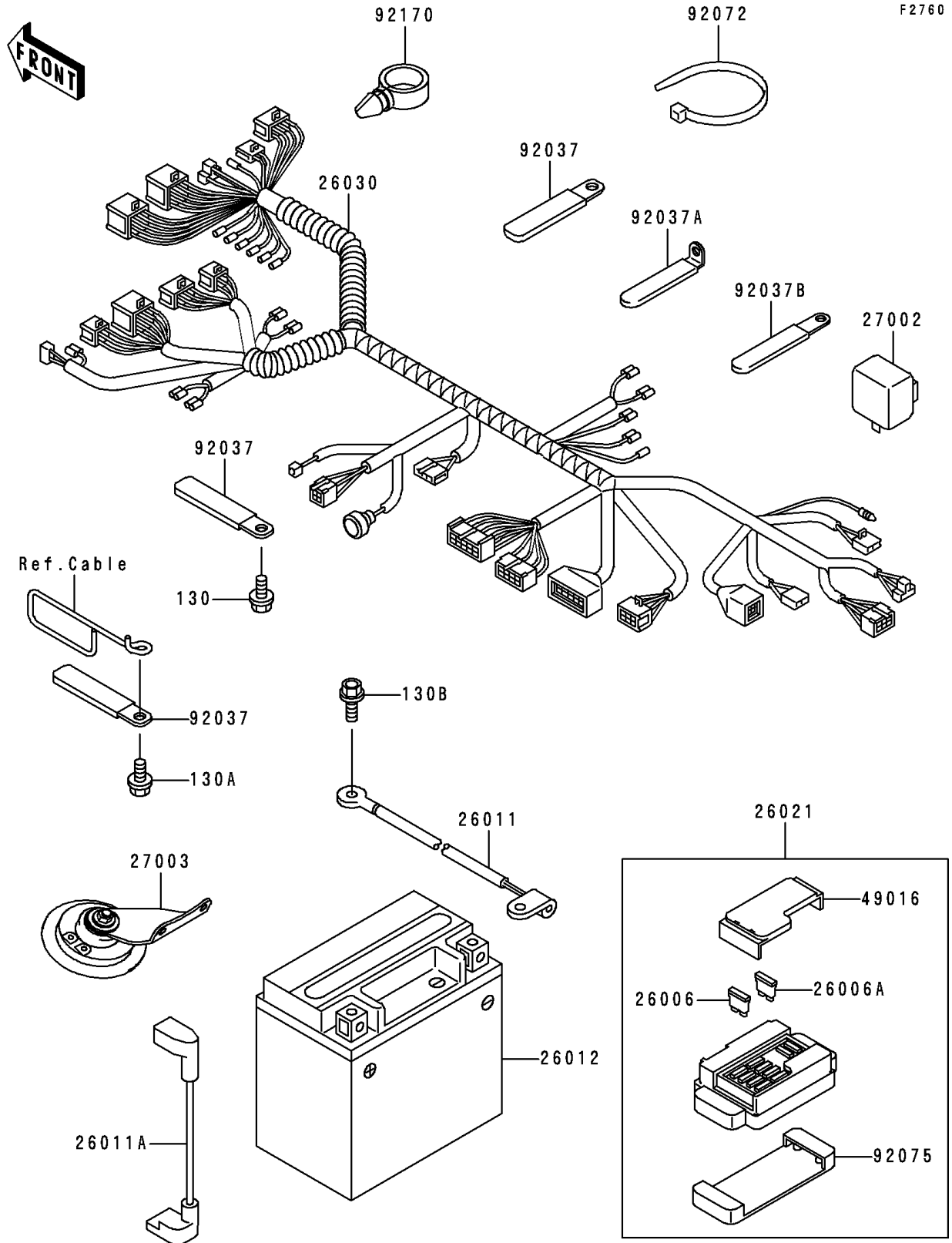

1995 NINJA® ZX™-6R PARTS LIST

Chassis Electrical Equipment

ITEM NAME	PART NUMBER	QUANTITY
BOLT-FLANGED,6X8 (Ref # 130)	130J0608	1
BOLT-FLANGED (Ref # 130A)	130J0612	1
BOLT-FLANGED,6X10 (Ref # 130B)	130V0610	1
FUSE,30A-G (Ref # 26006)	26006-1067	1
FUSE,10A-R (Ref # 26006A)	26006-1068	1
WIRE-LEAD,BATTERY(-) (Ref # 26011)	26011-1429	1
WIRE-LEAD,BATTERY(+) (Ref # 26011A)	26011-1625	1
BATTERY,YTX12-BS,12V 10AH (Ref # 26012)	26012-1281	1
JUNCTION BOX (Ref # 26021)	26021-1089	1
HARNESS,MAIN (Ref # 26030)	26030-1311	1
RELAY-ASSY,SIGNAL LAMP (Ref # 27002)	27002-1092	1
HORN (Ref # 27003)	27003-1381	1
COVER-SEAL,FUSE (Ref # 49016)	49016-1177	1
CLAMP,WIRING HARNESS,L=60 (Ref # 92037)	92037-1069	1
CLAMP (Ref # 92037A)	92037-1679	1
CLAMP (Ref # 92037B)	92037-1993	1
BAND,L=185 (Ref # 92072)	92072-1195	1
DAMPER,JUNCTION BOX (Ref # 92075)	92075-1688	1
CLAMP (Ref # 92170)	92170-1067	1