

2002 NINJA® ZX™-6 PARTS DIAGRAM

Oil Pan

E1434

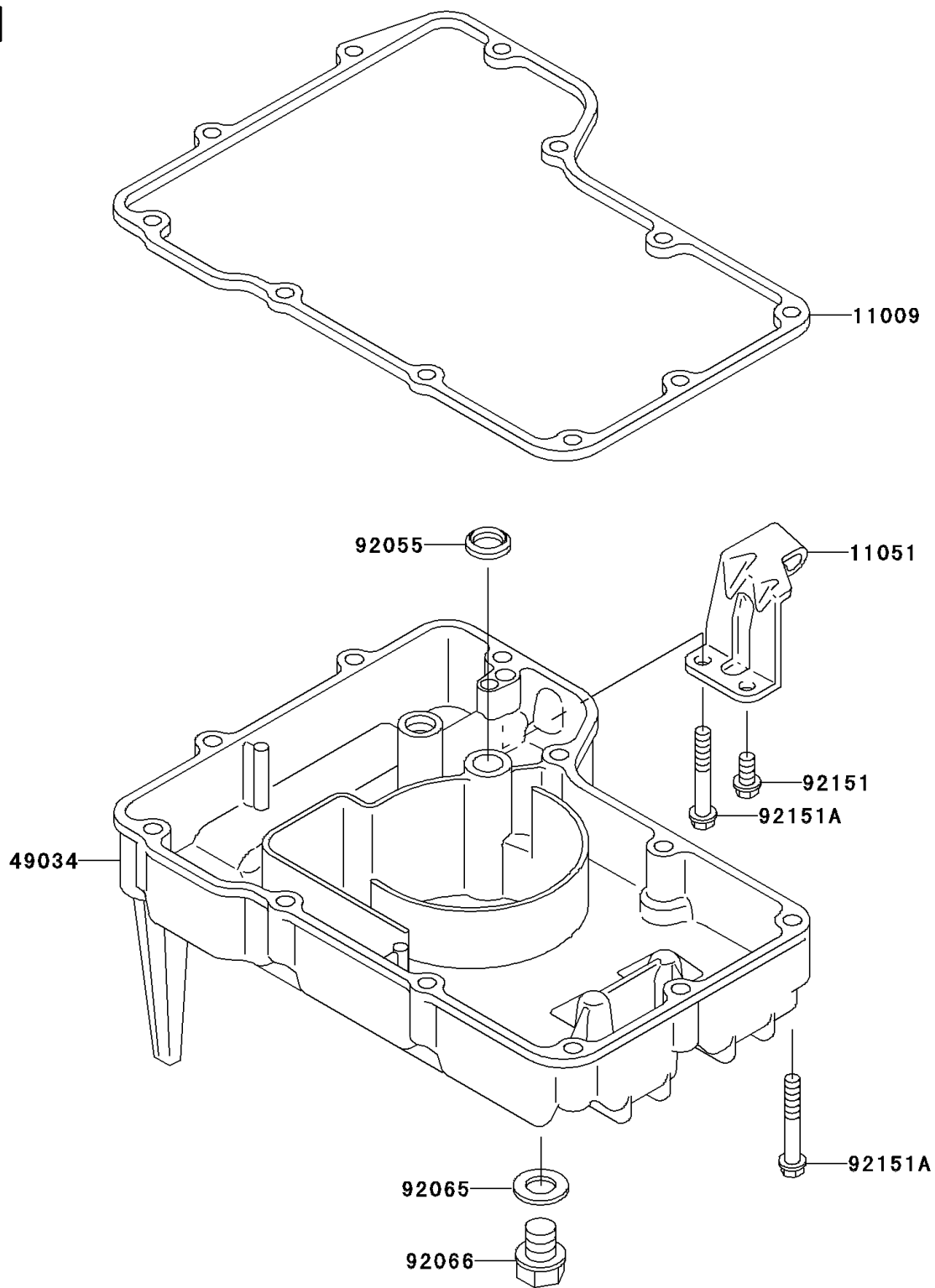

2002 NINJA® ZX™-6 PARTS LIST

Oil Pan

ITEM NAME	PART NUMBER	QUANTITY
GASKET,OIL PAN (Ref # 11009)	11009-1870	1
BRACKET (Ref # 11051)	11051-1997	1
PAN-OIL (Ref # 49034)	49034-1090	1
RING-O,OD=18 (Ref # 92055)	92055-048	1
GASKET,12X22X2 (Ref # 92065)	92065-097	1
PLUG,OIL DRAIN,12X15 (Ref # 92066)	92066-1174	1
BOLT,6X12 (Ref # 92151)	92151-1894	1
BOLT,6X40 (Ref # 92151A)	92151-1895	1